

## EPA Guidelines for Stormwater Management in Mount Gambier





**EPA GUIDELINES FOR STORMWATER MANAGEMENT  
IN MOUNT GAMBIER**

## EPA Guidelines for Stormwater Management in Mount Gambier

Text prepared by the Urban Water Resources Centre, Division of IT, Engineering and the Environment at the University of South Australia.

The development of this guideline was funded through contributions from the Environment Protection Authority, the City of Mount Gambier and the South East NRM Board.

This guideline was developed with valued contributions from the following partner organisations:

- City of Mount Gambier
- South East NRM Board
- DWLBC—Department of Water, Land and Biodiversity Conservation
- CSIRO—Land and Water
- District Council of Grant
- Department for Transport, Energy and Infrastructure
- SA Water.

*For further information please contact:*

*Information Officer  
Environment Protection Authority  
GPO Box 2607  
Adelaide SA 5001*

Telephone: (08) 8204 2004  
Facsimile: (08) 8124 4670  
Free call (country): 1800 623 445  
E-mail: [epainfo@epa.sa.gov.au](mailto:epainfo@epa.sa.gov.au)  
Internet: [www.epa.sa.gov.au](http://www.epa.sa.gov.au)

ISBN 1 876562 75 7  
February 2007

© Environment Protection Authority

This document may be reproduced in whole or part for the purpose of study or training, subject to the inclusion of an acknowledgment of the source and to its not being used for commercial purposes or sale. Reproduction for purposes other than those given above requires the prior written permission of the Environment Protection Authority.



*Printed on recycled paper*

## TABLE OF CONTENTS

<b>1</b>	<b>INTRODUCTION</b>	<b>1</b>
<b>2</b>	<b>HOW TO USE THIS GUIDELINE</b>	<b>2</b>
<b>3</b>	<b>BACKGROUND</b>	<b>4</b>
	General	4
	Stormwater drainage and disposal	4
<b>4</b>	<b>PRINCIPLES OF STORMWATER MANAGEMENT</b>	<b>7</b>
<b>5</b>	<b>PERFORMANCE CRITERIA FOR STORMWATER DISCHARGES</b>	<b>8</b>
	Water quality	8
	Flooding and retention capacity	9
<b>6</b>	<b>CHARACTERISTICS OF THE AREA</b>	<b>10</b>
	Climate	10
	Soils	11
<b>7</b>	<b>PLANNING METHODS FOR STORMWATER MANAGEMENT</b>	<b>13</b>
	Residential areas - allotment and cluster scale	13
	Neighbourhood scale	14
<b>8</b>	<b>STRUCTURAL METHODS FOR STORMWATER MANAGEMENT</b>	<b>18</b>
	Primary level treatment	18
	Secondary level treatment	18
	Tertiary level treatment	19
	On-site retention	19
	Structural methods suitability assessment	19
<b>9</b>	<b>DETAILED DESIGN OF STRUCTURAL METHODS</b>	<b>24</b>
	Gross pollutant traps	24
	Infiltration trenches	25
	Permeable pavement	29
	Kerblines strips	31
	Swales	32
	Retention basins	37
	Storage tanks	45
	Hydrocarbon interceptor and containment tanks	50
	Manufactured units with hydrocarbon separators	51
	Innovative solutions	52
<b>10</b>	<b>SUMMARY OF APPLICABILITY OF STORMWATER METHODS</b>	<b>53</b>
<b>11</b>	<b>CONSTRUCTION OF STORMWATER DISPOSAL BORES</b>	<b>54</b>
<b>12</b>	<b>PLANNING FOR MAINTENANCE AND MONITORING</b>	<b>55</b>
	Monitoring	55
	Maintenance	55
	Responsibility	56
<b>13</b>	<b>DOCUMENTATION FOR PLANNING APPLICATIONS</b>	<b>57</b>
<b>14</b>	<b>FURTHER READING</b>	<b>59</b>
<b>15</b>	<b>APPENDIX A - DOUBLE RING INFILTROMETER TEST</b>	<b>60</b>



## LIST OF FIGURES

Figure 1	Flow chart for the use of this guideline	3
Figure 2	South East Catchment and water protection area	5
Figure 3	Stormwater passage to the Blue Lake	6
Figure 4	Dominant soils of the Mount Gambier area	12
Figure 5	Typical WSUD techniques that can be applied at an allotment scale	13
Figure 6	Networked public open space incorporated in development	14
Figure 7	Integration of housing with waterway corridor	15
Figure 8	Conventional versus water-sensitive road layout	15
Figure 9	Conventional versus water-sensitive road cross-section	16
Figure 10	Verge design and management	16
Figure 11	Lot/street interface	17
Figure 12	Cul-de-sac streetscapes	17
Figure 13	Litter basket	24
Figure 14	Typical filter trench details for collecting roof runoff	26
Figure 15	Carpark with grass filter and filter trench system	27
Figure 16	Area ratio vs infiltration rate for infiltration trenches	28
Figure 17	Typical permeable pavement details	30
Figure 18	Kerblines strip	31
Figure 19	Examples of swales in Mount Gambier	32
Figure 20	Minimum length of swales	33
Figure 21	Storage volume required for swales discharging directly to a bore	34
Figure 22	Typical swale details	35
Figure 23	End of swale detail discharging to a bore	35-36
Figure 24	An option for bore protection using a removable shroud	36
Figure 25	Retention basin with gravel trench floor and gravel surround at bore	37
Figure 26	Large shallow basin incorporating swales	37
Figure 27	Retention basin details	39
Figure 28	Retention basin preliminary sizing charts	41-44
Figure 29	Rainwater storage tank	45
Figure 30	Rainwater tank yield curves for Mount Gambier	47-49
Figure 31	Manufactured unit ready for in-ground installation	51
Figure A1	Double ring infiltrometer	60
Figure A2	Setup of the double ring infiltrometer test	63

## LIST OF TABLES

Table 1	Stormwater treatment objectives	9
Table 2	Average monthly rainfall (mm) for Mount Gambier	10
Table 3	Mean daily evaporation (mm) for Mount Gambier	10
Table 4	Rainfall intensity for Mount Gambier (Lat. 37.83°S Long. 140.78°E)	11
Table 5	Contributory area screening tool	20
Table 6	Soil and subsoil infiltration rate screening tool	21
Table 7	Site constraints screening tool	22
Table 8	Pollutant management and cost constraints	23
Table 9	Summary of structural treatment measures for Mount Gambier	53



## 1 INTRODUCTION

The management and protection of stormwater has received greater attention in recent years as water management authorities and the community recognise the importance of water conservation and the role of stormwater in urban environments. There have been many guiding documents produced by governments, local councils, research organisations and private companies that provide the community with details of how they can protect stormwater quality, and thereby protect the surrounding natural water resources. Some of these have focused upon the treatment and design systems that can be applied in urban settings.

This guideline has been developed in response to the specific environmental setting and the historical stormwater management practices that have been applied in the South East region of South Australia. Although the focus is on Mount Gambier, the principles and techniques described are equally applicable across the region. The guideline is, however, developed mainly for urbanised areas.

Incorporating details of best management practices for stormwater management and treatment for both new developments and significant redevelopments, this guideline has been produced to help landowners and developers meet their environmental duty of care under section 25 of the *Environment Protection Act 1993* and their obligations under the *Environment Protection (Water Quality) Policy 2003*. This can be achieved by managing stormwater generated on their sites in a manner that minimises impacts on surrounding water resources, particularly the region's groundwater.

This guideline has been produced in conjunction with a comprehensive report. Readers who wish to read the comprehensive report on *Stormwater management in Mount Gambier - Structural Treatment Measures* should contact the Environment Protection Authority.

## 2 HOW TO USE THIS GUIDELINE

Stormwater management and disposal is complex, and it is not possible to provide a specific direction to landowners on what needs to be undertaken at all sites. Landowners can apply different stormwater management solutions depending on the size of the property, the depth to groundwater, the soil type, the topography and the use for that site. Although this allows flexibility to landowners to apply solutions that complement the purpose of the site, it also means that guidelines can only provide guidance on specific issues that need to be considered, rather than a single solution. Unfortunately, a 'one size fits all' approach is not possible.

In most cases at least a few options will be available, and this guideline provides information on how to choose the most appropriate option for each site.

Historically, stormwater management has focused on stormwater treatment at the point of discharge, whether this is at the street, river or sea. However, there is now recognition that better water quality outcomes can be achieved at reduced costs if effort is directed throughout the catchment to minimise the generation of stormwater needing treatment. The water-sensitive urban design (WSUD) concept has evolved to encompass many of these principles. This guideline has been structured to specifically recognise two important aspects of WSUD in stormwater management, namely planning methods (landuse planning) and structural methods (or treatment devices). Planning methods are those that can be incorporated into the planning of a site—normally a new site such as a residential land division. The benefit of using planning methods is that they can greatly reduce the amount of stormwater that needs to be treated for disposal. Structural methods include those systems that are installed to treat and dispose of the stormwater. All landowners should ensure that both aspects are appropriately considered in on-site stormwater management.

Although this guideline is reasonably comprehensive, it contains only a little of the extensive information that is available regarding stormwater management in urban areas. For issues of protection of stormwater from contamination, particularly during on-site construction activities, the reader is advised to consider the other documents and guidelines regarding the protection of stormwater (such as for bunding, vehicle washwater, domestic wastewater) that can be found on the EPA web site at [www.epa.sa.gov.au](http://www.epa.sa.gov.au).

In order to effectively use the information in this guideline, the reader should adopt the following approach when considering stormwater management on their site (Figure 1).

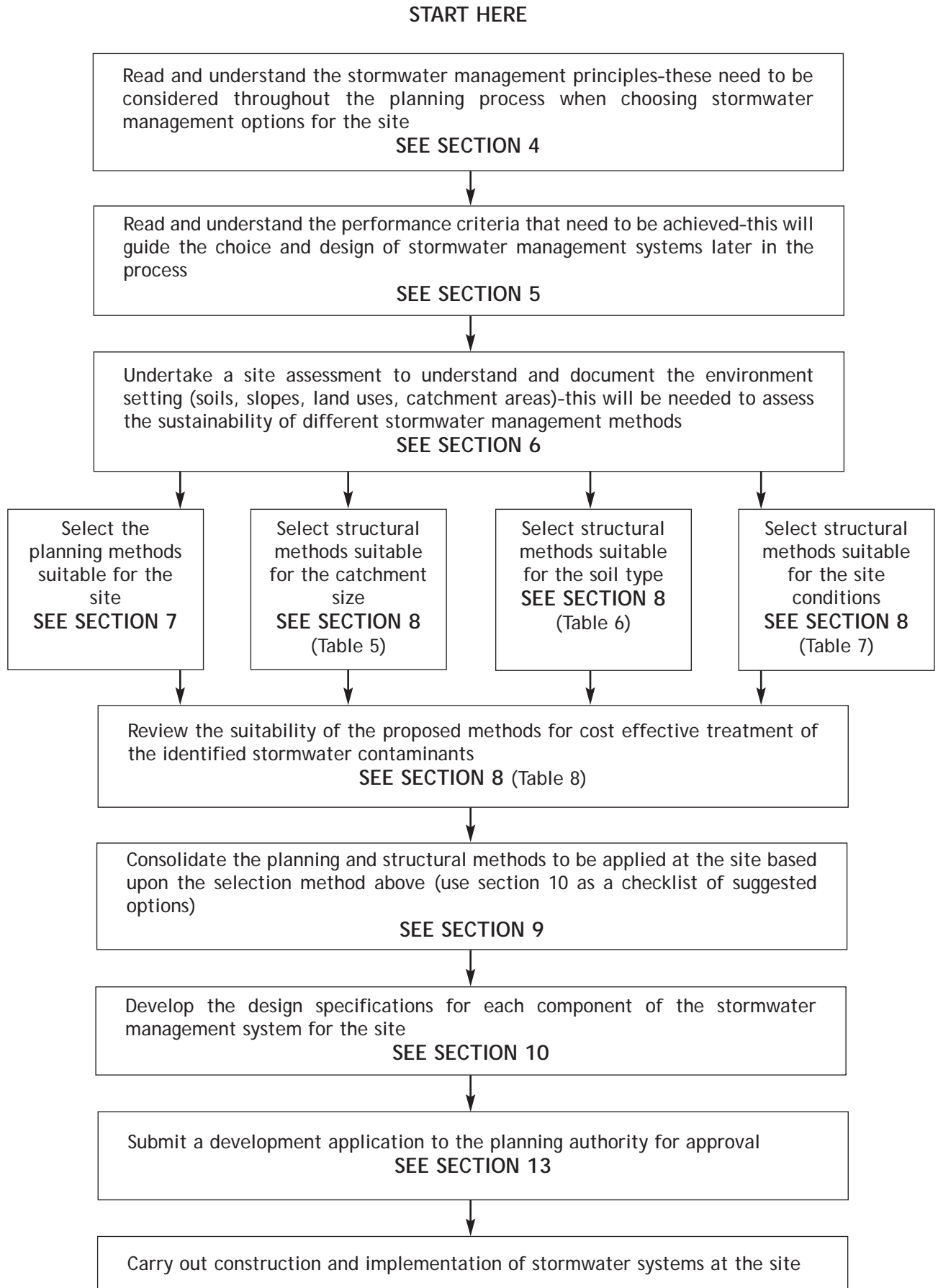

Figure 1 Flow chart for the use of this guideline

### 3 BACKGROUND

#### General

Mount Gambier is located in the South East region of South Australia, and is the only city (population 23,600) in the South East catchment, an area of 28,120 km<sup>2</sup> (Figure 2).

#### Stormwater drainage and disposal

Stormwater drainage in Mount Gambier is unusual, although not unique, in that stormwater is discharged directly through discharge bores to the underlying unconfined aquifer. This practice is widespread and is likely to have proliferated as a result of the topography of the region, which offers little surface drainage for stormwater.

There are approximately 400 council operated, and numerous other privately operated, discharge bores within the City of Mount Gambier. In the region it is estimated that there could be as many as 4000 discharge bores.

Developers must be aware that stormwater discharge results in direct recharge of the aquifer with stormwater, and in the Mount Gambier area this means that stormwater will ultimately find its way to the Blue Lake, the main water supply source for the city of Mount Gambier. The typical passage of stormwater from discharge bores to the Blue Lake is illustrated in Figure 3.

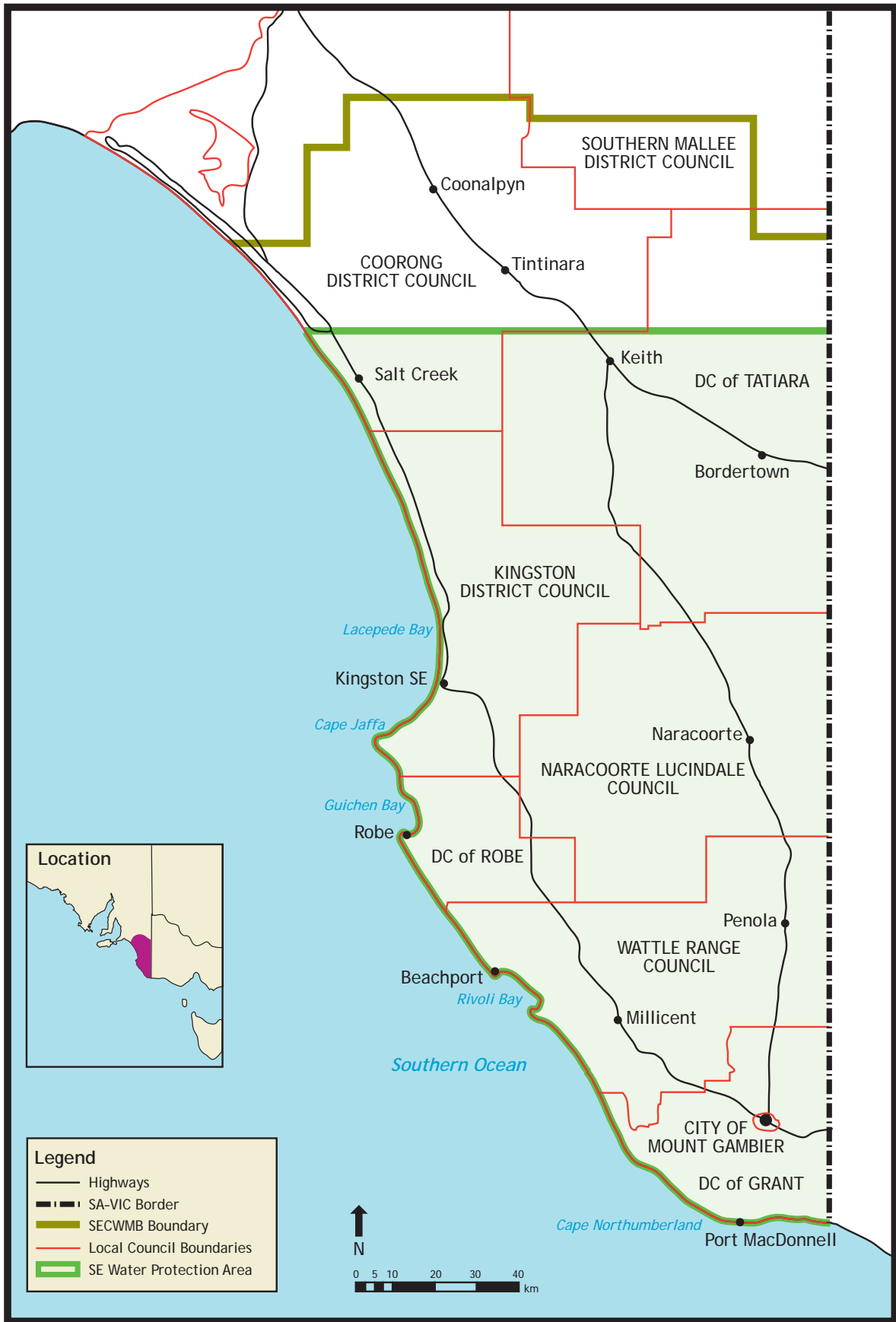

Figure 2 South East catchment and water protection area (source: SECWMB 2003)

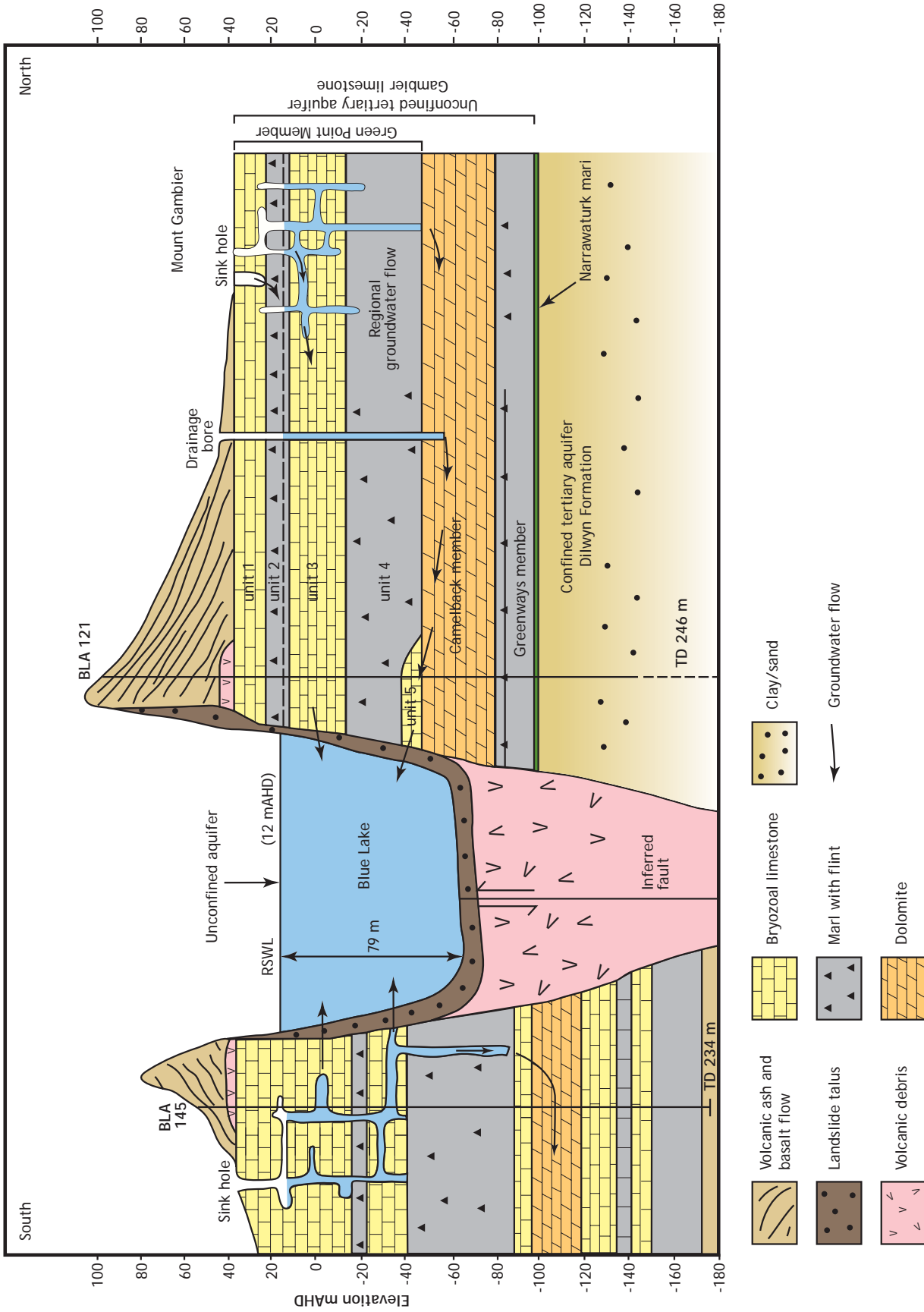

Figure 3 Stormwater passage to the Blue Lake (source: Hill et. al (2002))

## 4 PRINCIPLES OF STORMWATER MANAGEMENT

The detail and direction provided in this guideline have been based on a range of fundamental principles for stormwater management that need to be clearly understood. It is expected that the application of the suggested methods outlined in this document will be sufficient to achieve these principles; however, the reader and particularly any developers must ensure that these principles are fully considered in the design of any stormwater management system.

The principles for stormwater management in urban areas of the South East region are as follows:

- Stormwater discharges should not adversely affect receiving water resources (i.e. groundwater or surface water).
- Stormwater management should protect built assets from flooding or other damage.
- Stormwater should be treated to an acceptable standard on site before discharge.
- Non-interventional methods for stormwater management (such as good land-use planning) should be pursued in preference to interventional and high maintenance systems (such as treatment devices).
- Stormwater should be retained for maximum beneficial use.
- Every effort should be made to minimise the opportunities for stormwater to become contaminated and therefore require advanced treatment.
- Clean stormwater should be kept separate from contaminated stormwater to minimise the volumes needing to be treated.
- Where possible recharge should involve infiltration rather than direct discharge via wells to the aquifer.
- Stormwater systems should contain sufficient capacity and facilities to prevent spills entering groundwater.
- If possible, stormwater flow rates and volumes should mimic natural regimes.
- Storage should be built into the system to provide capacity and to reduce peak stormwater flow rates.

All landowners should consider the opportunities for implementing these principles when they are developing stormwater management plans for their sites.

## 5 PERFORMANCE CRITERIA FOR STORMWATER DISCHARGES

It is recognised that in many instances in the South East region there will be a requirement to discharge stormwater off site or to the underground aquifer. The principles for stormwater management in the region (see section 4) basically outline that there is a need to protect both receiving water quality as well as built assets. In respect to these issues, this guideline provides the following detail on achieving these principles.

### Water quality

As outlined in the principles in section 4, this discharge should not adversely affect the groundwater. Considering that the aquifers in the South East region provide much of the drinking water for the regional community, it is important that this resource is protected.

The *Environment Protection (Water Quality) Policy 2003* (Water Quality Policy) provides regulatory guidance on the measures that need to be taken to protect stormwater and groundwater in the state. There are a range of explanatory publications available on the protection of stormwater and groundwater ([www.epa.sa.gov.au](http://www.epa.sa.gov.au)). Two key aspects of the policy require that:

- people must not discharge pollutants into stormwater
- private landowners must ensure that any stormwater discharged to the aquifer must not degrade the quality of the groundwater.

Avoiding pollutant discharge to stormwater can be addressed through appropriate planning, land management, behavioural change and the provision of separate wastewater collection and treatment systems. Compliance with drinking water criteria is more complex as there are more than 50 compounds for which maximum concentrations in drinking water are defined within the policy. This guideline was developed to provide assistance to landowners on the best available technologies that are economically achievable for protection of the underlying groundwater aquifer. When landowners apply the solutions provided in this document, it is anticipated that the performance of the technology used will be adequate to achieve compliance.

In addition to the Water Quality Policy, any stormwater treatment system should achieve a minimum standard for treating stormwater as set out in Table 1. This demonstration of performance will include the use of acceptable modelling methods, such as MUSIC (CRC for Catchment Hydrology 2002), by suitably qualified professionals. A preferable manner in which to satisfy the water quality criteria is to not discharge stormwater directly to the aquifer but to rely on the soakage of stormwater through the soil profile.

Table 1 Stormwater treatment objectives

Pollutant	Stormwater treatment objective
Suspended solids (SS)	80% retention of the average annual load
Total phosphorous (TP)	45% retention of the average annual load
Total nitrogen (TN)	45% retention of the average annual load
Litter	Retention of litter greater than 50 mm for flow up to the 3-month average recurrence interval (ARI) peak flow
Coarse sediment	Retention of sediment coarser than 0.125 mm <sup>1</sup> for flows up to the 3-month ARI peak flow
Oil and grease	No visible oils for flow up to the 3-month ARI peak flow

Source: Australian Institution of Engineers 2003, chapter 1

Notes: (1) Based on ideal settling characteristics

### Flooding and retention capacity

The management of stormwater is made more difficult with the variability of flow events, and there is a need to provide a balance between the protection of water quality and the protection of property. In all instances, stormwater management must incorporate and consider the operation of the systems in response to high flow events. Additionally, each stormwater treatment system will need to have been designed to manage spills and emergency situations.

In general, both of these issues can be addressed through the provision of sufficient capacity to retain average flow events and reasonably foreseeable spills. In new developments retention capacity should be provided for at least the critical 1-in-1-year storm event before discharge (to bores or off site). Depending on local council requirements, it may also be necessary that all stormwater is retained and treated on site for any storms below the critical 1-in-100-year event.

## 6 CHARACTERISTICS OF THE AREA

### Climate

The annual average rainfall for Mount Gambier is 710 mm/year. The daily mean evaporation rate is 3.7 mm. The average monthly rainfall and the mean daily evaporation rate for Mount Gambier (Station: Mount Gambier Aero) are presented in Tables 2 and 3.

**Table 2 Average monthly rainfall (mm) for Mount Gambier**

Jan	Feb	Mar	Apr	May	Jun	Jul	Aug	Sep	Oct	Nov	Dec
26.2	25.4	35.4	55.0	71.7	83.5	99.3	93.5	72.9	62.7	46.6	37.4

**Table 3 Mean daily evaporation (mm) for Mount Gambier**

Jan	Feb	Mar	Apr	May	Jun	Jul	Aug	Sep	Oct	Nov	Dec
6.9	6.7	4.8	2.9	1.7	1.2	1.3	1.9	2.7	3.7	4.8	5.9

Details of the rainfall intensities for Mount Gambier, based on ‘Australian Rainfall and Runoff’ (AR&R) data (Pilgrim 1987), are provided in Table 4. These values are to be used when designing facilities for flood control.

Although these rainfall intensity values are for Mount Gambier, landowners may wish to also use these values for other areas of the region as a default. Because the Mount Gambier area will generally have a higher rainfall and lower evaporation rate when compared to other parts of the region, any system that has been designed based on these figures should provide adequate stormwater management capacity. Alternatively, site-specific rainfall and evaporation figures may be sourced.

Table 4 Rainfall intensity for Mount Gambier (Lat. 37.83° S Long. 140.78° E)

Duration	Average recurrence interval (ARI)						
	1 year (mm/hr)	2 year (mm/hr)	5 year (mm/hr)	10 year (mm/hr)	20 year (mm/hr)	50 year (mm/hr)	100 year (mm/hr)
15 min	24.3	32.5	44.2	53.0	64.0	82.0	97.0
30 min	16.9	22.4	29.9	35.4	42.8	54.0	63.0
45 min	13.4	17.7	23.4	27.4	33.0	41.3	48.3
1 hr	11.2	14.8	19.4	22.7	27.2	33.9	39.5
1.5 hr	8.79	11.6	15.0	17.5	20.8	25.8	30.0
2 hr	7.37	9.65	12.5	14.4	17.2	21.2	24.5
2.5 hr	6.41	8.39	10.8	12.4	14.8	18.1	21.0
3 hr	5.72	7.47	9.56	11.0	13.0	16.0	18.4
3.5 hr	5.20	6.77	8.64	9.93	11.7	14.3	16.5
4 hr	4.78	6.22	7.92	9.08	10.7	13.1	15.0
5 hr	4.16	5.40	6.84	7.82	9.19	11.2	12.8
6 hr	3.71	4.81	6.06	6.92	8.12	9.85	11.3
7 hr	3.37	4.37	5.48	6.24	7.31	8.85	10.1
8 hr	3.10	4.01	5.02	5.71	6.68	8.07	9.22
9 hr	2.88	3.72	4.65	5.28	6.16	7.43	8.49
10 hr	2.70	3.48	4.34	4.92	5.74	6.91	7.88
11 hr	2.55	3.28	4.08	4.61	5.38	6.47	7.37
12 hr	2.41	3.11	3.85	4.35	5.07	6.09	6.93
14 hr	2.18	2.80	3.47	3.92	4.56	5.47	6.22
16 hr	1.99	2.57	3.17	3.58	4.16	4.99	5.67
18 hr	1.85	2.37	2.93	3.30	3.83	4.59	5.22
20 hr	1.72	2.21	2.73	3.07	3.56	4.27	4.84
22 hr	1.61	2.07	2.55	2.87	3.33	3.99	4.53
24 hr	1.52	1.95	2.40	2.71	3.14	3.75	4.25
30 hr	1.31	1.68	2.06	2.31	2.68	3.19	3.62
36 hr	1.15	1.47	1.81	2.03	2.34	2.79	3.16
42 hr	1.03	1.32	1.61	1.81	2.09	2.49	2.82
48 hr	0.94	1.20	1.46	1.64	1.89	2.25	2.54
54 hr	0.86	1.1	1.34	1.49	1.72	2.05	2.31
60 hr	0.79	1.01	1.23	1.37	1.58	1.88	2.12
66 hr	0.73	0.94	1.14	1.27	1.47	1.74	1.96
72 hr	0.68	0.87	1.06	1.18	1.36	1.62	1.82

### Soils

Soils in the Mount Gambier region are generally volcanic sands with good infiltration capacity. Most stormwater management practices described in this guideline make use of this capacity for the treatment of stormwater. The map below (Figure 4) shows the dominant surface soil types within the greater Mount Gambier area; however, given the heterogeneity of soils, a specific site assessment should always be undertaken on each site before planning stormwater treatment methods. In addition, soil profile information may be available from DWLBC.

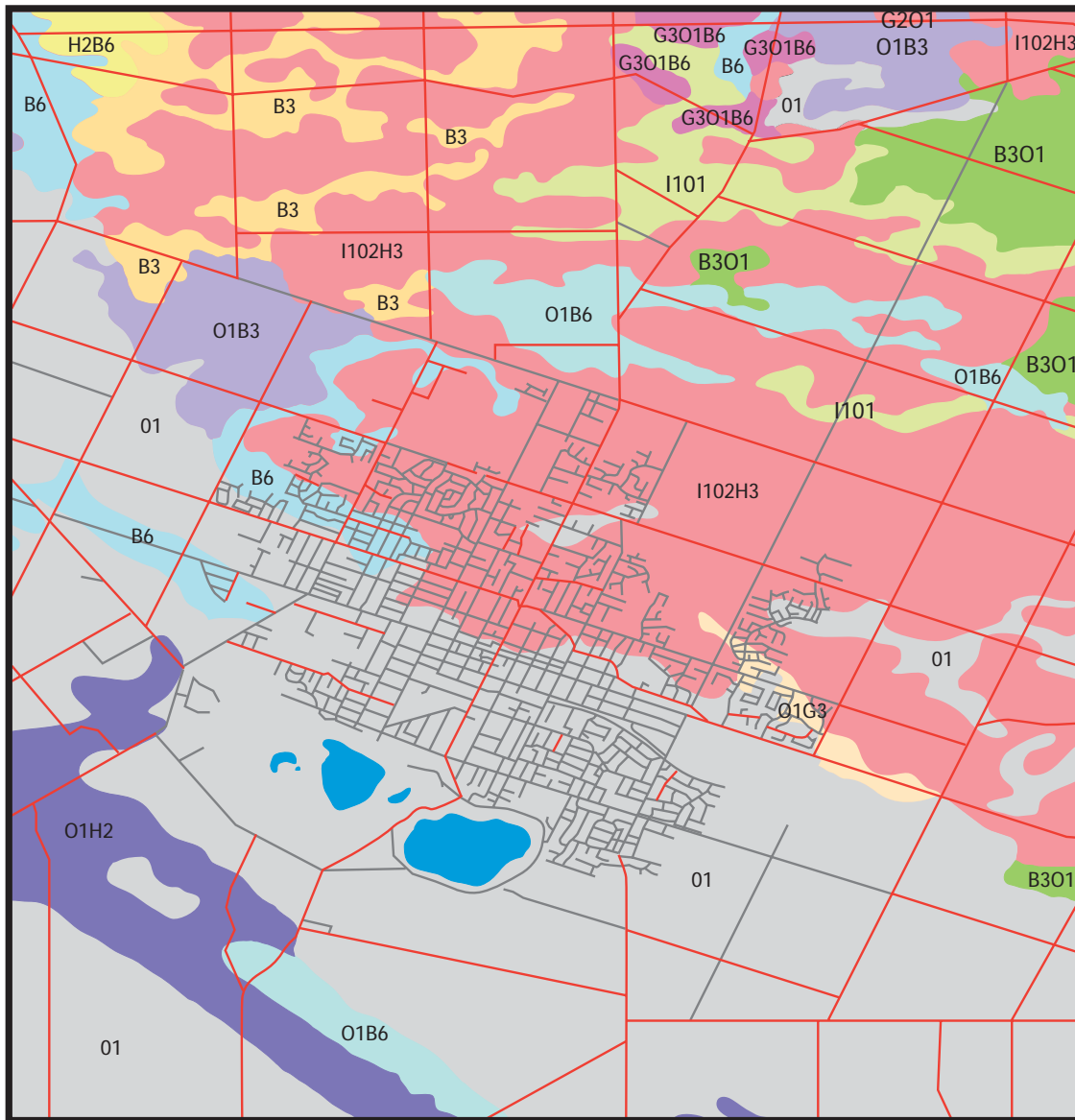

**Dominant soil type**

- B3 - Shallow sandy loam on calcrete
- B301 - Shallow sandy loam on calcrete and volcanic ash soil
- B6 - Shallow loam over red-brown clay on calcrete
- G301B6 - Thick sand over clay and volcanic ash soil and sandy loam over red-brown clay on calcrete
- H2B6 - Siliceous sand and shallow loam over red-brown clay on calcrete
- I101 - Highly leached sand and volcanic ash soil
- I101H3 - Highly leached sand and volcanic ash soil and bleached siliceous sand
- O1 - Volcanic ash soil
- O1B3 - Volcanic ash soil and shallow sandy loam on calcrete
- O1B6 - Volcanic ash soil and shallow loam over red-brown clay on calcrete
- O1G3 - Volcanic ash soil and thick sand over clay
- O1H2 - Volcanic ash soil and siliceous sand

**Figure 4** Dominant soils of the Mount Gambier area (Source: Soil Landscapes, DWLBC)

## 7 PLANNING METHODS FOR STORMWATER MANAGEMENT

Developers are encouraged to incorporate water-sensitive urban design (WSUD) concepts into developments during the planning stage. These methods not only provide enhanced water quality and a reduction in stormwater quantity, but also offer the developer opportunities for enhanced social and environmental amenity, which may improve selling potential. Generally speaking, WSUD aims to minimise the impact of urbanisation on the urban water cycle. WSUD concepts can be applied at the allotment scale as well as at the neighbourhood scale. Each concept is discussed in the following sections.

Some important features to recognise within the planning methods are:

- use of more water-sensitive flowing lines instead of the conventional rigid line approach to development
- reduced impervious areas
- landscaped links between public and private areas
- improvement of visual amenity, public access and passive recreational activities
- preservation, minimum disturbance and where possible the incorporation of existing native vegetation in stormwater design systems
- treatment of pollution and encouragement of detention and infiltration of stormwater
- reduced cost of stormwater pipe network due to a lower required capacity.

Although the planning methods focus upon residential areas, the concepts can also be applied to non-residential areas. Developers and designers should consider the opportunities for the application of these concepts in other developments during the design phase.

### Residential areas—allotment and cluster scale

At an allotment or cluster level the use of rainwater tanks, underground storage tanks, filter trenches, permeable pavement and vegetated swales are all appropriate. Typical measures that can be included in typical urban developments are indicated in Figure 5.

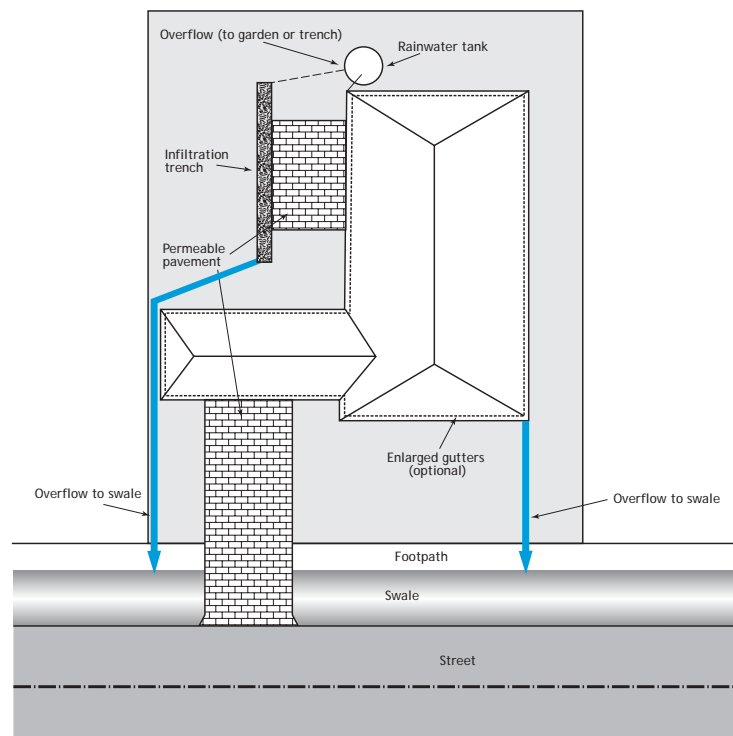

Figure 5 Typical WSUD techniques that can be applied at an allotment scale

### Neighbourhood scale

Generally, the main concept will be to direct runoff water to a dedicated drainage line or open space area before discharge to the river. Residential development can be built around these open space areas, enhancing not only water quality but also visual amenity. In such cases, because the basin can be built over a larger area, it can also be a shallower structure. The current requirement by the City of Mount Gambier for new developments is for an open space area to be 12.5 % of the total area.

Generally, the incorporation of swales and basins into the stormwater system will reduce the need for the typical triple chamber structure currently used extensively in the region. In areas where the risk of hydrocarbon contamination is considered to be high (e.g. at carparks, service stations), it would be more appropriate to consider other oil separator systems. Although hydrocarbon contaminants will still exist on road surfaces, these can be effectively removed by treatment processes through grassed swales, gravel trenches and detention basins. Other contaminants such as coarse and fine sediments and nutrients can also be effectively removed in this manner. Reliance on the proper functioning of the treatment devices system for removal of contaminants is also eliminated. Typical examples of how water-sensitive urban design concepts can be incorporated at a neighbourhood scale are shown in Figures 6 to 12 (CSIRO 1999).

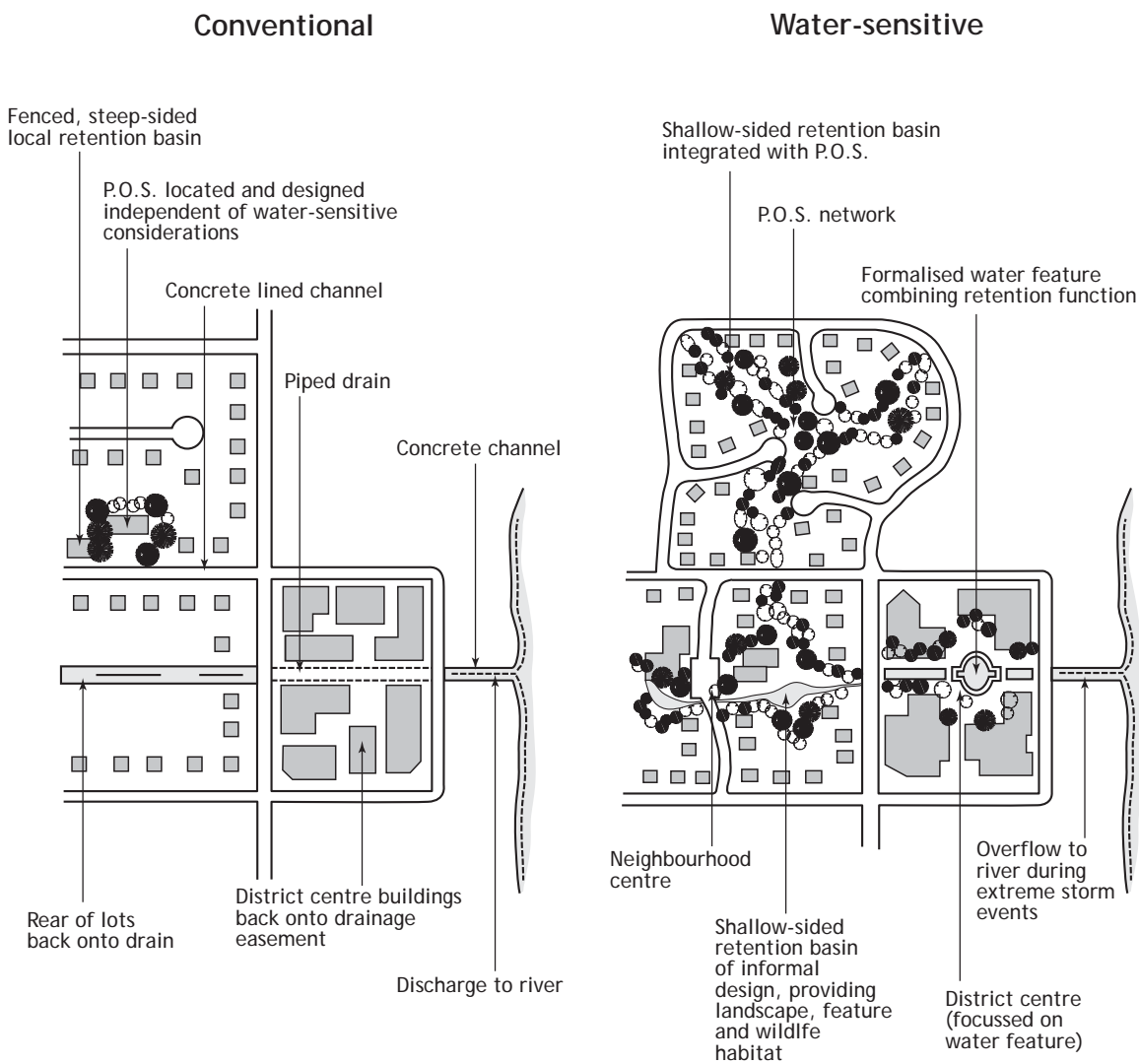

Figure 6 Networked public open space (P.O.S.) incorporated in development



Figure 7 Integration of housing with waterway corridor

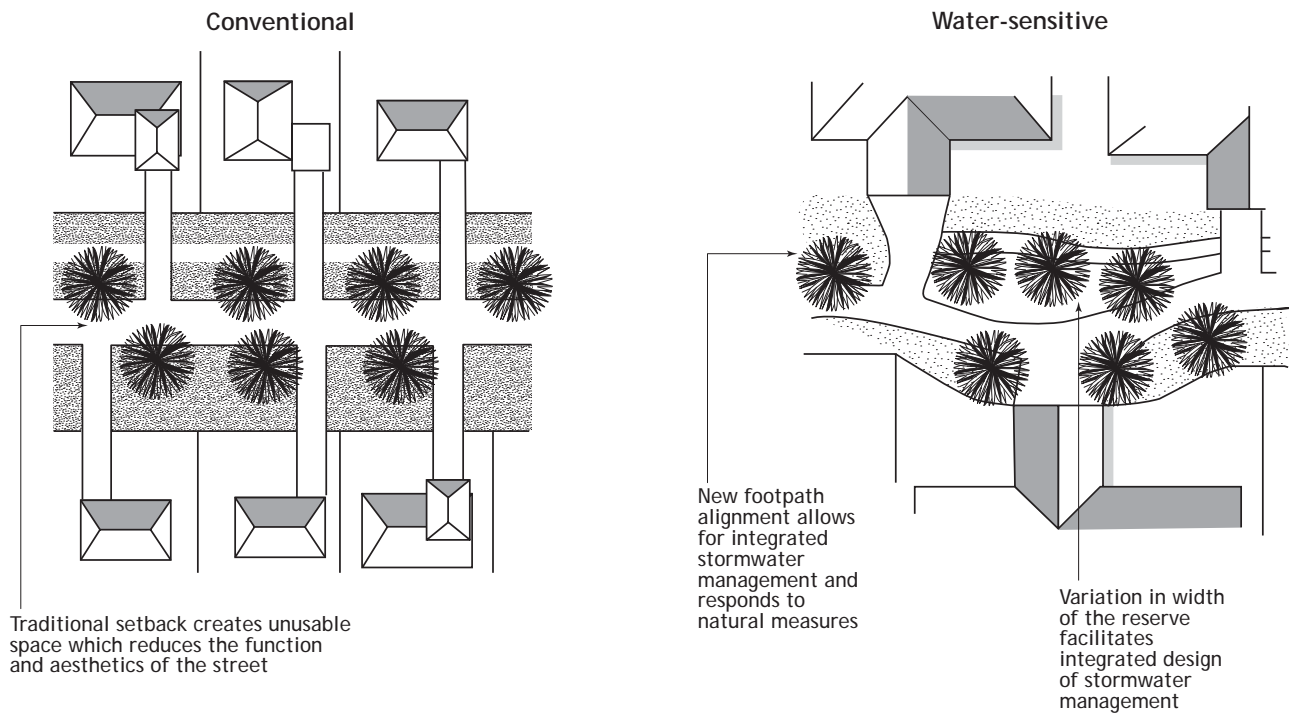

Figure 8 Conventional versus water-sensitive road layout

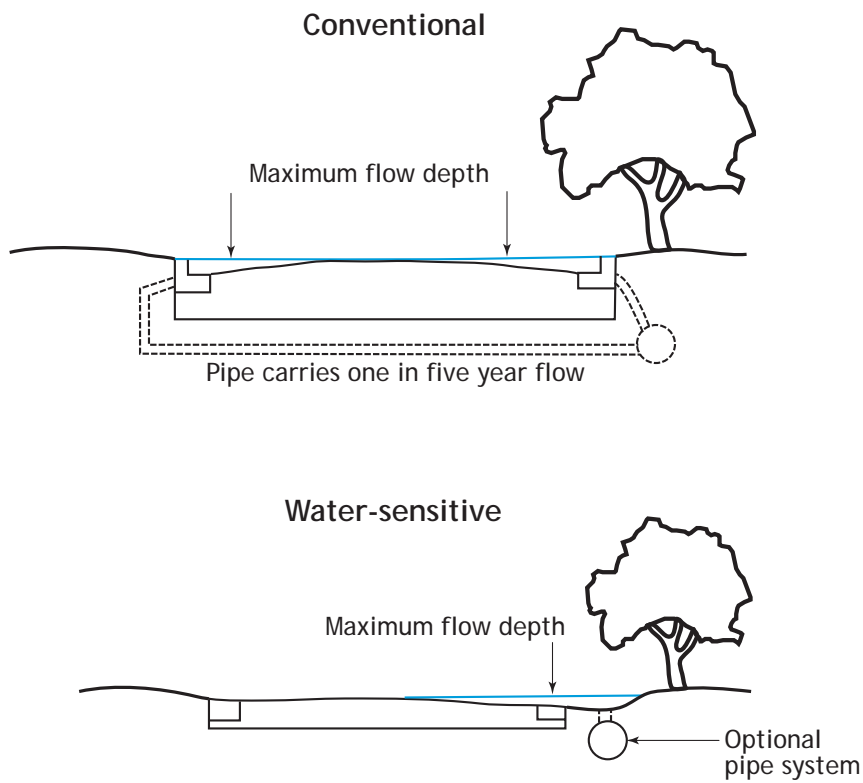

Figure 9 Conventional versus water-sensitive road cross-section

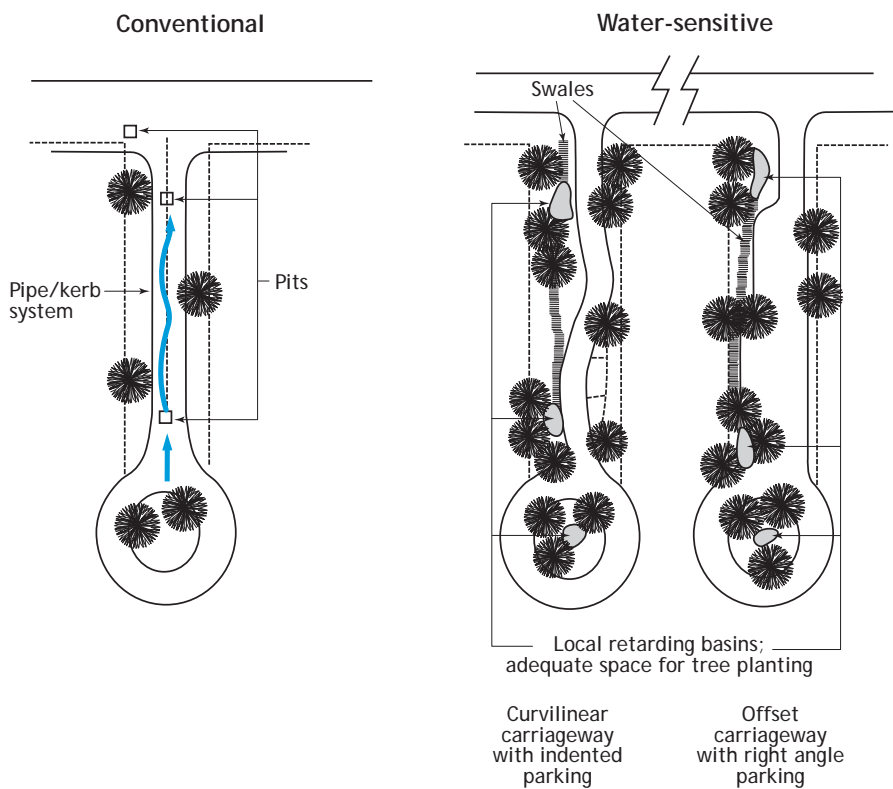

Figure 10 Verges design and management

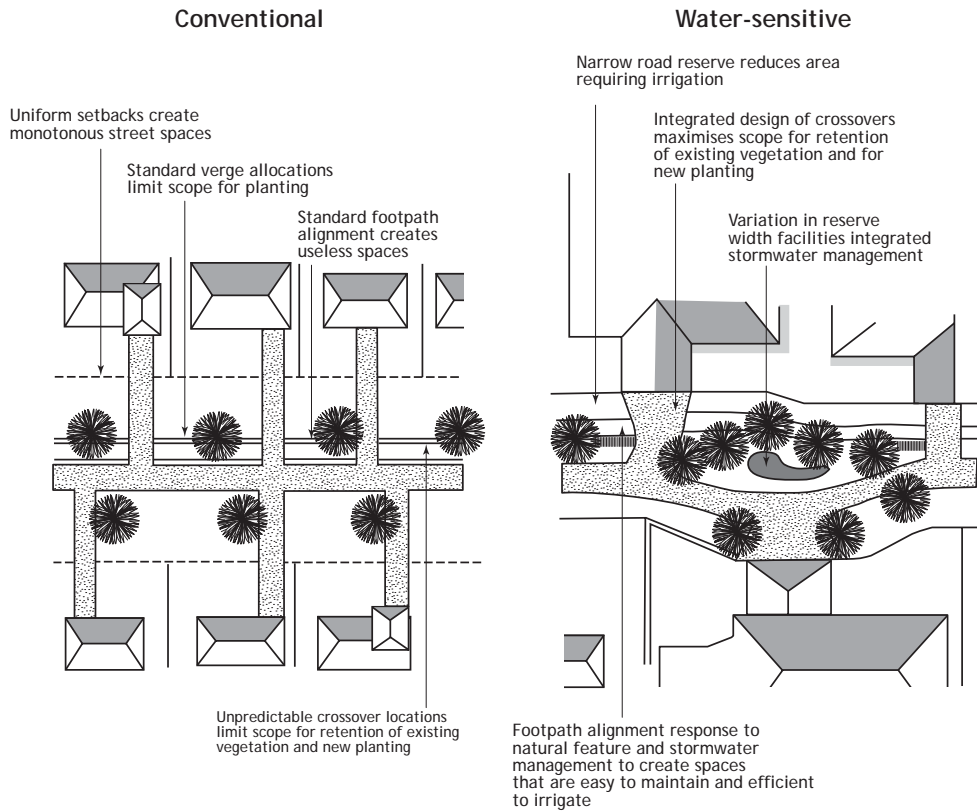

Figure 11 Lot/street interface

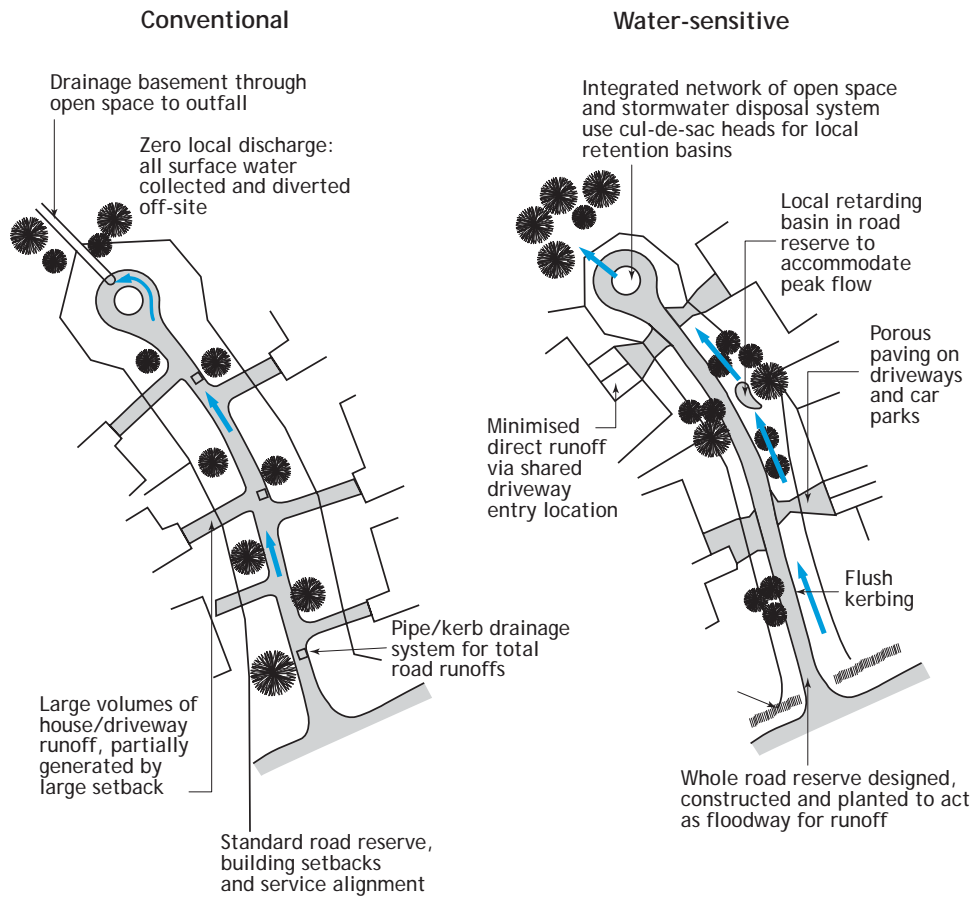

Figure 12 Cul-de-sac streetscapes

## 8 STRUCTURAL METHODS FOR STORMWATER MANAGEMENT

Structural methods include treatment and storage techniques designed to remove pollutants from urban stormwater. Generally, pollutant removal can be considered as a three-stage process (primary, secondary and tertiary) based on dominant treatment processes. In most cases the use of a combination of treatment techniques that remove pollutants through different processes should provide the best overall treatment of stormwater runoff. This approach has the advantage of being more robust—that is, a failure of one treatment technique or measure will not necessarily result in the complete failure of the system.

### Primary level treatment

The dominant treatment processes at the primary level include physical screening of gross pollutants and rapid sedimentation of coarse particles. This allows for the removal of a portion of the inflow litter and coarse sediment.

Typical types of primary treatment measures include (NSW EPA 1997):

- well intakes that inhibit entry of floating films
- litter baskets and pits—wire or plastic baskets installed in a stormwater pit to collect litter from a paved surface (litter basket) or within a piped stormwater system (litter pit)
- trash racks—series of metal bars located across a channel or pipe to trap litter and debris
- sediment traps—structures placed within the stormwater system or upstream of other treatment mechanisms to trap coarse sediment; they can take the form of a formal tank or less formal pond
- in-line gross pollution traps—sediment traps with a litter (or trash) rack, usually located at the downstream end of the trap
- litter booms—floating devices installed in channels and waterways to collect floating litter and oil
- catch basins—drainage pits with depressed bases to collect sediment
- oil/grease and sediment separators—generally consist of three underground retention chambers designed to remove coarse sediment and hydrocarbons.

### Secondary level treatment

At the secondary level the dominant treatment processes include the sedimentation of finer particulates and filtration. This aids in the removal of suspended solids and allows removal of some nutrients and metals. Typical types of secondary treatment measures include (NSW EPA 1997):

- upflow activated carbon filters for organics removal
- filter strips—grassed or vegetated areas that treat overland flow, often adjacent to watercourses
- vegetated swales—grass-lined channels for conveying runoff from roads and other impervious surfaces
- dry extended detention basins—basins that store runoff for 1-2 days and drain to an essentially dry condition between storm events
- wet detention basins—shallow basins that have a permanent pool of water and are designed to store runoff for a relatively short period of time
- sand filters—beds of sand (or other media) through which runoff is passed; the filtered runoff is then collected by an underdrain system
- infiltration trenches—shallow, excavated trenches filled with gravel through which runoff drains to groundwater
- infiltration basins—open excavated basins that are designed to infiltrate runoff through the floor of the basin
- permeable pavements—pavements that allow runoff to drain through a coarse graded concrete/asphalt pavement or open concrete blocks, subsequently to infiltrate to the underlying soil.

### **Tertiary level treatment**

At the tertiary level the dominant treatment processes include enhanced sedimentation and filtration, biological uptake and adsorption of sediments. This allows improved retention of nutrients and heavy metals. Until recently, the main tertiary treatment technique has been the constructed wetland system (NSW EPA 1997), comprising:

- ponds (or deep water zones)—open water that might have submerged plants, but with emergent macrophytes around the fringe (littoral macrophytes)
- wetlands—areas vegetated with emergent plants and including various vegetation zones distinguished by depth, frequency and duration of inundation.

### **On-site retention**

On-site retention will reduce the volume of stormwater runoff and therefore also reduce the transport of contaminants entering the stormwater system. By reducing the quantity of runoff, downstream water quality treatment systems are able to operate more effectively. On-site retention techniques such as above-ground (rainwater tanks, enlarged gutters, etc.) and below-ground tanks are typically used to store roof runoff and can provide a clean source of water for use on site.

### **Structural methods suitability assessment**

The following tables are presented as an aid to developers to gauge the appropriateness of a treatment measure (adapted from Transport SA 2002). As treatment measures are site specific, these tables can be used to initially screen out measures that are not appropriate for the site to be developed. Further information on each of these measures is available in the comprehensive version of this report from the EPA.

Assessment should include the consideration that:

- the structural system is appropriate for the catchment size (Table 5)
- the structural system is appropriate for the soil type (Table 6)
- the structural system is appropriate given the site's environmental characteristics (Table 7)
- the capital and maintenance costs for the structural system are appropriate (Table 8).

Table 5 Contributory area screening tool

Operations—phase treatment measures	Contributing catchment area (ha)									
	Preferred			4-6	6-8	8-10	10-15	15-20	20-40	40>
	<1	1-2	2-4							
Permeable paving	A	A	L	-	-	-	-	-	-	-
Infiltration trenches	A	A	-	-	-	-	-	-	-	-
Kerblin turf strips	A	-	-	-	-	-	-	-	-	-
Filter strips	A	A	L	-	-	-	-	-	-	-
Vegetated swales	A	A	L	-	-	-	-	-	-	-
Upflow activated carbon filtration	A	L	-	-	-	-	-	-	-	-
Catch basins and litter baskets	A	L	L	L	-	-	-	-	-	-
Sediment traps	-	-	L	L	L	A	A	A	L	L
Infiltration basins	-	L	A	A	L	-	-	-	-	-
Sand filters	A	A	A	A	L	L	L	L	-	-
Bioretention/reed bed systems	A	A	L	-	-	-	-	-	-	-
In-line gross pollutant traps	Device dependent - seek manufacturer's advice									
Manufactured unit with hydrocarbon separator	Device dependent - seek manufacturer's advice									
Dry extended detention basins	-	-	L	L	A	A	A	A	A	A
Wet detention basins	-	-	L	L	A	A	A	A	A	A
Trash racks and booms	-	-	L	L	L	A	A	A	L	-
Constructed wetlands	-	-	L	L	A	A	A	A	A	A

Notes:

- A Appropriate for the treatment measure.
- L Generally limited use for this treatment measure at this scale. Subject to a combination of treatments being used this may be an appropriate treatment at this scale
- Not appropriate scale for the treatment measure.

Table 6 Soil and subsoil infiltration rate screening tool

Operations—phase treatment measures	Soil type for infiltration rate constraint								
	Sand	Loamy sand	Sandy loam	Loam	Silty loam	Sandy-clay loam	Clay loam	Sandy clay	Silty clay or clay
Permeable paving	A	A	A	A	L	P	P	P	P
Infiltration trenches	A	A	A	A	L	P	P	P	P
Kerbline turf strips	A	A	A	A	A	A	A	A	A
Filter strips	A	A	A	A	A	A	A	L	L
Vegetated swales	A	A	A	A	A	A	A	L	L
Upflow activated carbon filtration	A	A	A	A	A	A	A	A	A
Catch basins and litter baskets	A	A	A	A	A	A	A	A	A
Sediment trap	A	A	A	A	A	A	A	A	A
Infiltration basins (dry ponds)	A	A	A	A	L	P	P	P	P
Sand filters	A	A	A	A	A	A	A	A	A
Bioretention/reed bed systems	L	L	L	L	L	L	L	L	L
In-line gross pollutant traps	Device dependent—seek manufacturer's advice								
Manufactured unit with hydrocarbon separator	Device dependent - seek manufacturer's advice								
Dry extended detention basins	A	A	A	A	A	A	A	A	A
Wet detention basins	L	L	L	A	A	A	A	A	A
Trash racks and booms	A	A	A	A	A	A	A	A	A
Constructed wetlands	L	L	L	A	A	A	A	A	A

## Notes:

A Generally not a limitation for the treatment measure.

P Usually a problem (constraint) for installing the treatment measure.

L May be a limitation for installing the treatment measure, but can usually be overcome through appropriate design.

**Table 7 Site constraints screening tool**

Operations—phase treatment measures	Potential constraint								
	Steep slope	High watertable	Shallow bedrock	Space limitation	Needs subsurface installation	High sediment input	Requires pre-treatment	Hydraulic head loss limitation	Installation in a tidal system
Permeable paving	P	P	P	P	A	P	A	L	P
Infiltration trenches	P	P	P	L	A	P	A	L	P
Kerbline turf strips	P	P	L	P	A	L	L	A	P
Filter strips	P	P	L	P	P	A	A	A	P
Vegetated swales	P	P	L	P	P	A	A	A	P
Upflow activated carbon filtration	L	P	P	L	A	L	A	L	P
Catch basins and litter baskets	A	A	A	A	A	L	A	L	L
Sediment trap	A	A	L	L	A	L	L	L	L
Infiltration basins (dry ponds)	P	P	P	P	L	P	A	L	P
Sand filters	A	A	A	A	A	L	L	P	L
Bioretention/reed bed systems	P	P	P	P	A	L	L	P	A
In-line gross pollutant traps	Device dependent—seek manufacturers advice								
Manufactured unit with hydrocarbon separator	Device dependent - seek manufacturer's advice								
Dry extended detention basins	L	L	L	P	P	P	A	L	L
Wet detention basins	L	L	L	P	P	P	A	L	L
Trash racks and booms	A	A	A	A	L	L	A	P	L
Constructed wetlands	P	L	L	P	P	L	A	L	L

Notes:

- A Generally not a limitation for the treatment measure.
- P Usually a problem (constraint) for installing the treatment measure.
- L May be a limitation for installing the treatment measure, but can usually be overcome through appropriate design.

**Table 8 Pollutant management and cost constraints**

Operations—phase treatment measures	Pollutant category				Relative cost		
	Dissolved	Fine sediment association	Fine sediment	Coarse	Gross	Capital	Ongoing
Permeable paving	••	•••	•••	•••••	•	\$\$\$\$	\$\$\$
Infiltration trenches	••	•••	•••	•••••	•	\$\$\$	\$\$\$
Kerbline turf strips	•	••	•••	•••	•	\$	\$\$\$
Filter strips	•	••	••	•••••	••	\$	\$
Vegetated swales	•	••	••	••••	•	\$	\$
Catch basins and litter baskets	-	-	•	••	•••	\$\$	Device dependent
Sediment trap	-	•	•	•••••	-	\$\$\$	\$\$\$
Infiltration basins (dry ponds)	••	•••	•••	••••	-	\$\$	\$\$\$\$\$
Sand filters	•	•••	•••	••••	•	\$\$\$\$	\$\$\$\$
Bioretention/reed bed systems	•	••	•••	••••	•	\$\$\$\$	\$\$\$
In-line gross pollutant traps	-	•	••	••••	•••••	\$\$\$\$	\$\$\$
Manufactured unit with hydrocarbon separator	Device dependent - seek manufacturer's advice						
Dry extended detention basins	•	••	••	••••	•	\$\$	\$\$\$\$
Wet detention basins	•	•••	•••	••••	•	\$\$\$\$	\$\$\$
Trash racks and booms	-	-	-	-	•••	\$	\$\$
Constructed wetlands	••	••••	••	••••	••	\$\$\$\$	\$\$\$

Notes:

Pollutant category (removal effectiveness):

- Negligible <10 %
- Low 10% to 40 %
- Low to moderate
- Moderate 40% to 60 %
- Expected moderate to high
- High 60% to 80 %

Relative cost: Low \$; Low-moderate \$\$; Moderate \$\$\$; Moderate-high \$\$\$\$; High \$\$\$\$\$

## 9 DETAILED DESIGN OF STRUCTURAL METHODS

This section of the guideline provides the design detail for the structural stormwater treatment methods that are considered appropriate for application in and around Mount Gambier. Structural methods not described in detail in this section are generally not applicable or require demonstration of performance through appropriate modelling (see 'Innovative solutions' at the end of section 9).

Detailed designs are provided for:

- gross pollutant traps
- infiltration trenches
- permeable pavement
- kerbside strips
- swales
- retention basins
- storage tanks
- hydrocarbon interceptor and containment tanks
- manufactured units with hydrocarbon separators
- innovative solutions.

### Gross pollutant traps

#### Description

Gross pollutant traps are designed to be inserted into stormwater pipe systems to prevent gross pollution such as litter and leaves from entering discharge bores. The most appropriate forms for Mount Gambier are litter baskets and proprietary built devices. An example of a litter basket is shown in Figure 13.

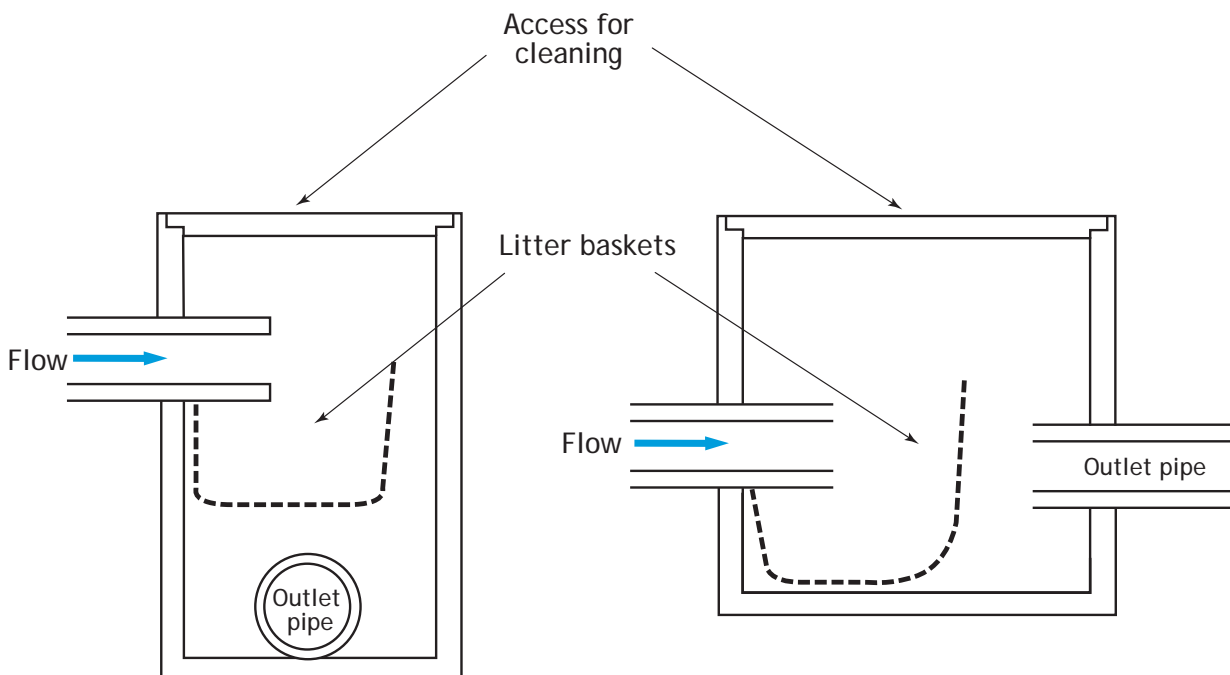

Figure 13 Litter basket (Sources: Transport SA 2002; CSIRO 1999)

### Typical applications

These devices would be most applicable at discharge points to sinkholes, retention basins and swales. They are also appropriate in areas that generate high litter loads, such as shopping centres and schools. However, they are not necessary for devices when the installation of a shroud at the entrance to the discharge bore would provide a similar function (see Figure 24).

### Limitations

- They require regular cleaning to perform adequately.

### Design

- They must not have a significant impact on the hydraulics of the pit or pipe system when fully blocked.
- Allowances should be made for inspection, maintenance and cleaning.

### Construction

- Appropriate concrete chambers are required at each location.

### Maintenance

- Regular cleaning out and removal of gross pollutants to an approved disposal site should be carried out at a typical maintenance frequency of 3 to 6 months.
- Occupational health and safety standards should be adhered to during periods of maintenance, inspection and repair as trapped pollutants may be hazardous.

## Infiltration trenches

### Description

Infiltration trenches are excavated trenches or pits, lined with geotextile fabric and backfilled with clean coarse gravel, into which stormwater is directed. The stormwater is temporarily stored in the trench or pit prior to infiltrating to the surrounding soil. These devices are generally used as a source control measure for sediments which will reduce the quantity of stormwater entering the stormwater discharge system.

### Typical applications

Due to the favourable infiltration capacity of soils in Mount Gambier, these are highly applicable in this region. They are generally used to capture runoff with low sediment loads and would thus be most suitable at the outlets of roof downpipes or paved areas that have low sediment loads. Typical details of filter trenches for collecting roof runoff are shown in Figure 14. Trenches may also be connected to drainage wells, particularly for larger systems.

### Limitations

- They should not be used without pre-treatment devices in areas that have high sediment loads.
- Infiltration capacity may be reduced by fine sediment deposits.
- The soil infiltration capacity will determine the effectiveness of infiltration measures; Appendix A provides a procedure for estimating in-situ infiltration capacity using the double ring infiltrometer.
- Generally, they can not be used in steeply sloped areas (i.e. slopes greater than 5%).
- Generally, they should not be used in areas that have received waste fill.
- They are not suitable for areas with high water tables.
- They are not to be used in clay or sodic soils that are prone to collapse on contact with water.

## Design

- The design is influenced by contributory area, quality and quantity of runoff, soil infiltration capacity and soil characteristics.
- Low infiltration rates may result in unacceptably long draindown times.
- Where space permits, a grass filter strip or swale is recommended upstream of filter trenches, and is considered essential for carpark areas; a typical example of an application for a carpark area is shown in Figure 15.
- Wrapping trenches in geotextile will prevent the ingress of fines.
- A perforated pipe within the trench will allow a more even distribution of stormwater runoff to the trench.
- An overflow must be provided to direct excess flows to the stormwater system.
- Consideration of soil moisture and swell is important when locating gravel trenches near buildings and other structures.

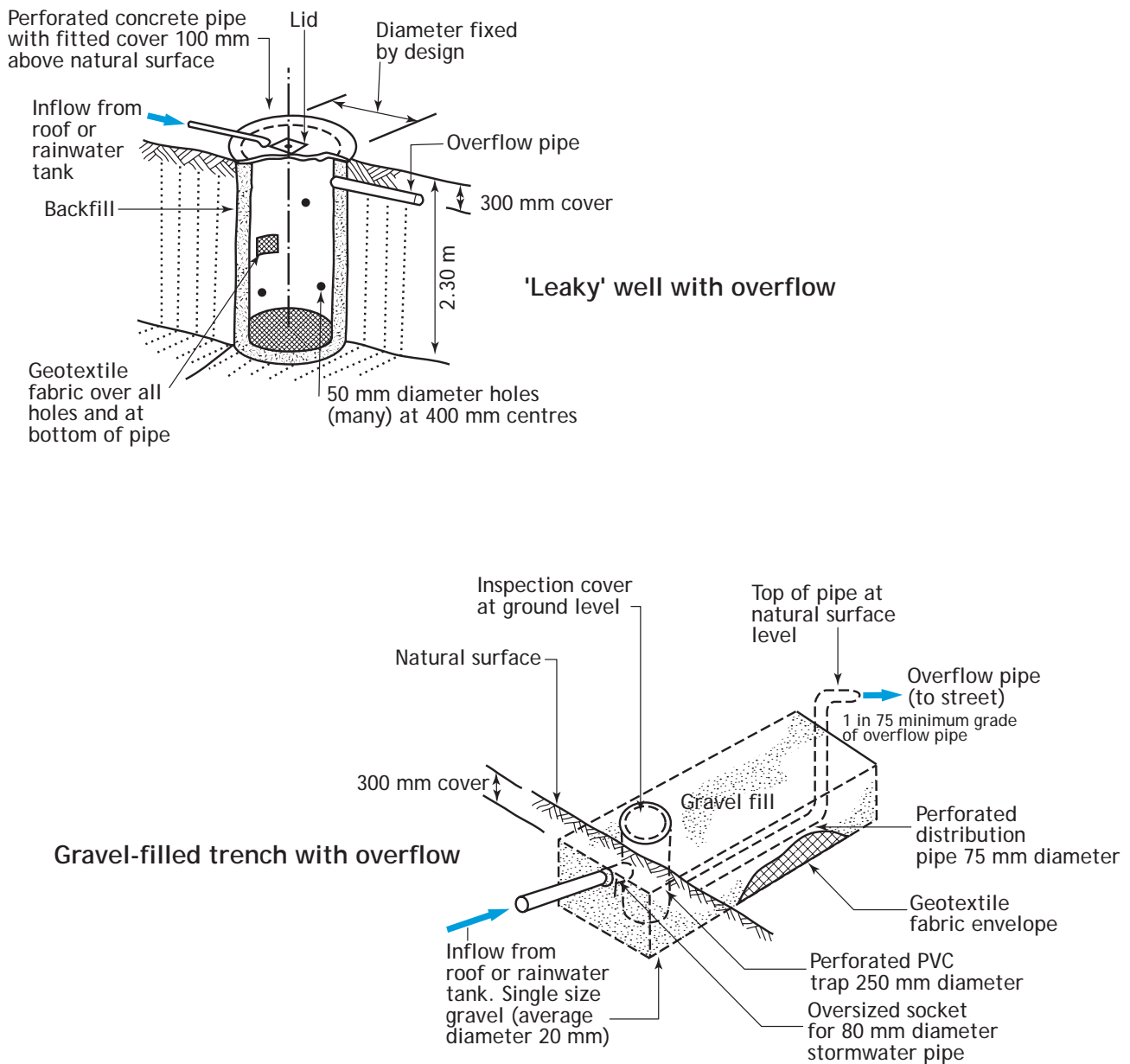

Figure 14 Typical filter trench details for collecting roof runoff (Source: CSIRO 1999)

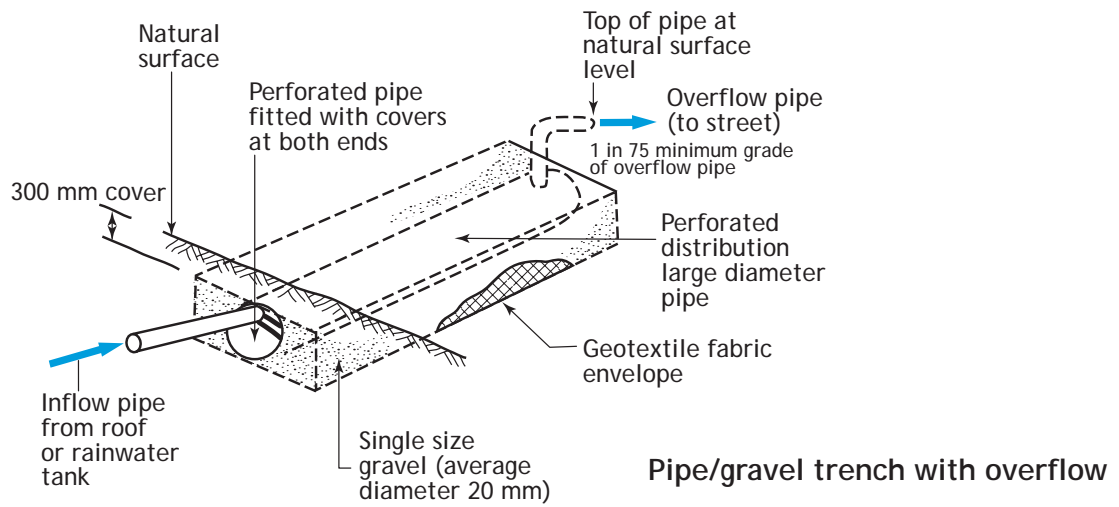

Figure 14 (cont) Typical filter trench details for collecting roof runoff

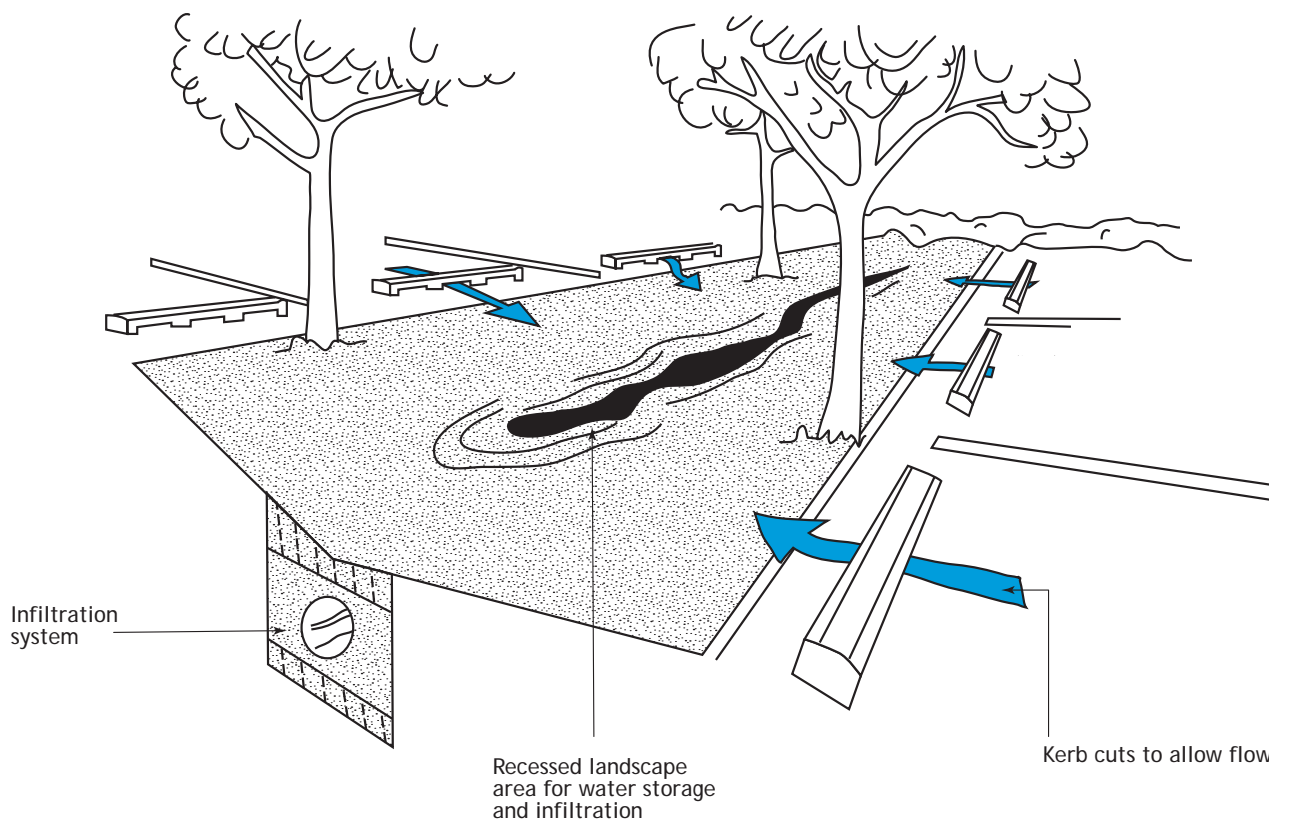
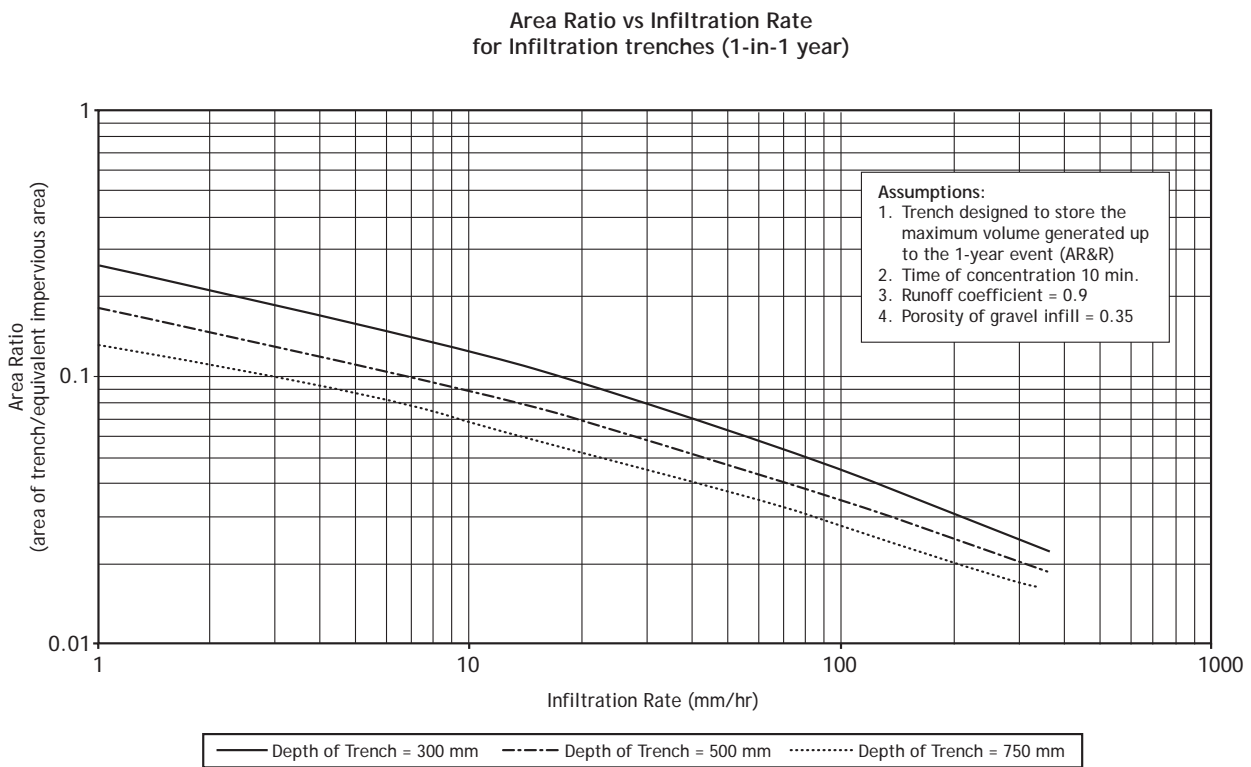

Figure 15 Carpark with grass filter and filter trench system (Source: CSIRO 1999)

- According to the minister’s specification SA78AA, September 2003 ‘On-site retention of stormwater’:
  - Retention devices shall be located a minimum of three (3) metres from all property boundaries (excluding front boundaries and/or reserves) and 3 metres from footings of all structures located on the allotment.
  - A minimum clear spacing of 1 metre between the sides of the retention device and any service trench is required.
  - Where two or more retention devices are installed, the clear distance between the edges of the devices shall be 1.5 times the depth of the deepest device.
- The following chart (Figure 16) can be used to determine the size of the trench necessary to receive runoff from an impermeable surface for varying soil infiltration rates. The assumptions are listed in the figure. The size of the trench determined should be capable of storing events up to a 1-in-1 year (24 hour) storm event before any discharge (to bores or offsite). Soil infiltration rates should be determined using the procedure in Appendix A.



**Figure 16 Area ratio vs infiltration rate for infiltration trenches (1-in-1 year)**

**Example**

For a site where the soil infiltration rate is 36 mm/hr (typical for sandy clay or sandy loam):

- The area ratio for a trench 500 mm deep is 0.054
- For a contributory equivalent impervious area of 1000 m<sup>2</sup>, the area of the trench is 54 m<sup>2</sup> (1000 x 0.054); a suitable trench size can be 27 x 2.0 x 0.5 m.
- This will allow full containment for storms up to a 1-in-1 year event.

## Construction

- It is essential that sediment from construction activities does not enter the trench.
- Preferably, these trenches should be constructed once other construction activities have concluded in the area.
- Gravel must be clean, well washed and free of fines.
- Compaction of the base of the trench should not occur.
- Inspection of the trench should be undertaken by a suitably qualified engineer before placement of geotextile to ensure that the infiltration capacity of the excavated trench has not been compromised.
- Non-woven geotextile should be used to line the trench to prevent the ingress of fines into the trench; the geotextile should extend over the top of the trench if topsoil is used.
- Before placing gravel, the bottom of the trench may be scarified to improve infiltration.

## Maintenance

- Performance of the trenches should be monitored to ensure proper functioning, including signs of surface ponding in the vicinity of the trench, and water levels in the trench wherever piezometers are installed.
- Pre-treatment devices must be inspected and maintained.
- The top filter fabric should be replaced if clogged.
- The entire trench should be replaced if the base becomes clogged.
- Pesticides and herbicides should not be used in the infiltration trench.

## Permeable pavement

### Description

Permeable pavements allow stormwater to infiltrate through to the paving substrate and ultimately into the underlying soil. Permeable pavements can:

- provide on-site retention of stormwater runoff
- reduce the overall volume of stormwater runoff from the site
- reduce the export of sediments and pollutants off site.

### Typical applications

Due to the favourable infiltration capacity of soils in Mount Gambier, these are highly applicable in this region. They are mostly suited to areas not exceeding 0.25 ha with low sediment loadings, and particularly suitable for carpark areas or low traffic areas surrounding houses and buildings. A typical detail of a permeable pavement is shown in Figure 17, with further examples in Figures 5 to 12.

### Limitations

- They are only suitable for areas with light traffic loads.
- They should not be used in areas with anticipated high sediment loads, unless some form of pre-treatment is provided.
- They are not suitable for steep grade areas (>5 %).
- They are only suitable for small catchment areas (up to 0.25 ha).
- They should only be used in fully established areas.

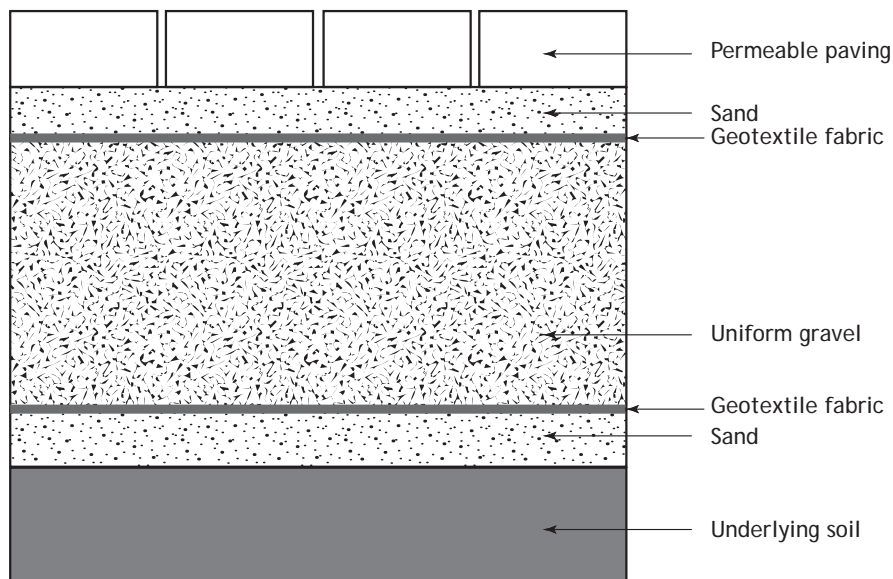

Figure 17 Typical permeable pavement details

### Design

- Pavement slopes should be graded at 1% or less, but not exceed 5%.
- The underlying soil must have a moderate infiltration rate as low infiltration rates may result in an unacceptably long infiltration time; Appendix A provides a field test for determining infiltration rates using the double ring infiltrometer.
- The ratio of contributory impervious area to permeable area should not be greater than 2:1 (Argue *et al.* 2003).
- A deep gravel bed may underlay the permeable pavement to provide a temporary storage prior to infiltration to the surrounding soil; the chart in Figure 16 can be used to size the gravel bed.
- A perforated pipe may be included in the gravel bed to collect and direct the percolated stormwater to another site; an impermeable liner should be used to enclose the bed in this case.
- Designers should be familiar with the manufacturer's recommendations.

### Construction

- It is essential that sediment arising from construction activities does not enter the porous pavement area.
- Where the design allows for infiltration to the surrounding soil, the area receiving the permeable pavement should not be compacted.
- Installers should be familiar with the permeable pavement manufacturer's recommendations.

### Maintenance

- Because permeable pavements are prone to clogging, routine inspection is essential for the proper performance of the pavement.
- Accumulated sediments can be removed using high-suction vacuum cleaners or high-pressure hoses.

## Kerblines strips

### Description

Kerblines strips are used upstream of concrete kerbing to trap sediment and prevent it entering the street drainage system. They are generally at least 400 mm in width and extend the full length of the kerbing. A typical detail of a kerblines strip is shown in Figure 18.

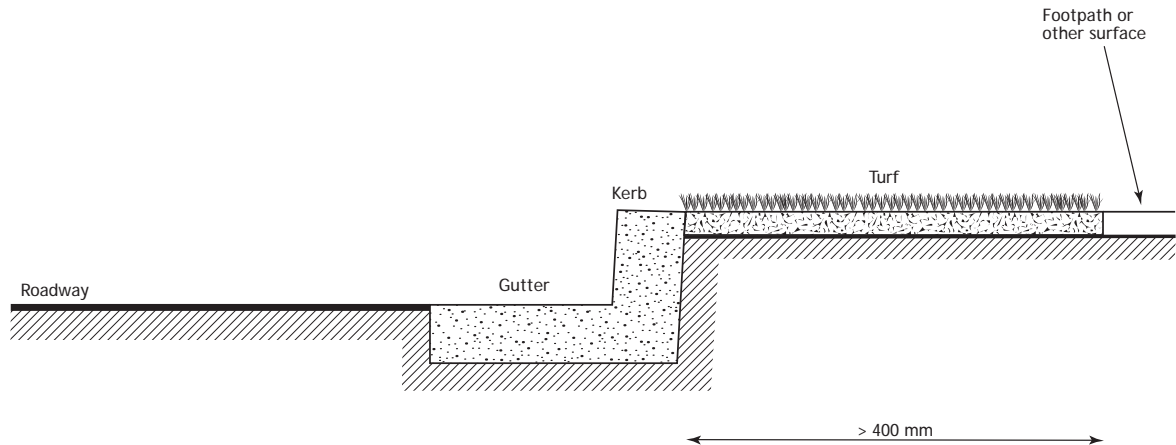

Figure 18 Kerblines strip (Sources: Transport SA 2003; NSW Dept. of Housing 1998)

### Typical applications

These devices are preferred to the gravel material that is currently used in Mount Gambier, which can easily wash off into the street and into the stormwater system. Their use is also applicable during the construction phase of development.

### Limitations

- They must be placed at kerb height to enable the turf to act as a barrier to water and sediment that travels toward the road from upstream areas.

### Design

- To ensure easy maintenance, drought resistant grass should be used.
- They should extend the full length of the kerbing and be a minimum of 400 mm in width.
- They should be protected from erosion due to surface runoff or high sediment loading from adjacent areas.
- The depth of soil in the features must be at least 300 mm to provide a growth media for vegetation, and to filter any pollutants.

### Construction

- The turf must be installed at kerb height.
- The area behind the strip should be protected by paving or vegetation.
- Turf strips should be fenced off to prevent access until fully developed.
- They should be protected from high sediment loads and runoff until fully established.

### Maintenance

- Irrigation and maintenance of the strips will ensure a dense vegetative coverage.
- Turf strips should be checked for wear, and worn or dead sections repaired.
- Pesticide application should be limited to minimise the direct ingress of pesticides into the stormwater system.

## Swales

### Description

Swales are vegetated or grassed lined channels that primarily convey runoff, but also have the ability to treat runoff through processes of filtration and infiltration during low flow events.

### Typical applications

Swales can be incorporated into new developments along road verges and carparks, and in and around retention basins. They can provide a multipurpose benefit, including:

- recreational use
- aesthetics
- improvement in property prices
- improved stormwater treatment.

A few examples in use in Mount Gambier are shown in Figure 19.



Figure 19 Examples of swales in Mount Gambier

### Limitations

- They are generally only suitable for slopes up to 4%.
- They are generally only suitable for contributory areas up to 5 ha.
- They should not be used in soils that are highly erodible.
- They require a larger area than equivalent kerb and gutter systems.
- They are not effective to receive runoff from construction areas where sediment loads are high.

### Design

- Swales must be designed to ensure that erosion is unlikely to result; this includes the use of check dams for slopes greater than 4% and scour and erosion protection at concentrated inflow points or areas where flow velocities might be high (e.g. outside bends for curved swales).
- The velocity of flow should not exceed 0.3 m/s during a 1-in-1-year event, and 1.0 m/s during a 1-in-100-year event.
- The required swale size can be determined using Manning's equation.
- For low flow events (up to a 1-in-1-year event) Manning's  $n$  of 0.15 to 0.2 is appropriate, and for higher flow events a value of 0.03 is appropriate.

- The flow depth for a 1-in-1-year event should not exceed one-third of the grass height in infrequently mowed grass, or one-half the height of regularly mowed grass, to a maximum of 75 mm.
- Swales are generally trapezoidal in shape with bottom widths ranging from 0.6 to 2.5 m.
- Side slopes are generally determined with regards to maintainability; typically, side slopes are 5H:1V maximum, although swales that cross driveways or other pavement areas must match the crossover grade (generally 13H:1V maximum).
- Swales do not necessarily need to be straight and should be blended with existing land forms to improve aesthetics.
- The length of the swale should provide a minimum 9-minute retention time for a 1-in-1-year event; the minimum length of the swale should not be less than 30 m.
- The following curve (Figure 20) provides a guide in determining the length of swales for varying development sizes and longitudinal slopes; the curve is for a single development connecting to a single swale, and the assumptions are listed on the figure; the minimum length shown complies with the minimum 9-minute retention time during a 1-in-1-year event and also ensures that treatment objectives are met (based on continuous modelling for an average rainfall year using MUSIC software (CRC for Catchment Hydrology 2002).
- The depth of soil in the features must be at least 300 mm to provide a growth media for vegetation, and to filter any pollutants.

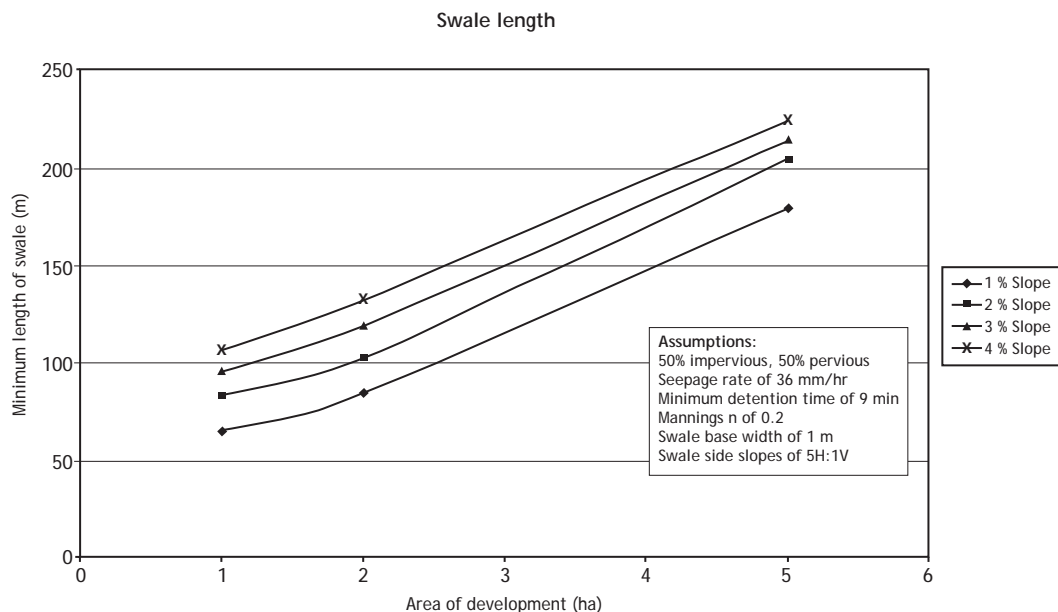
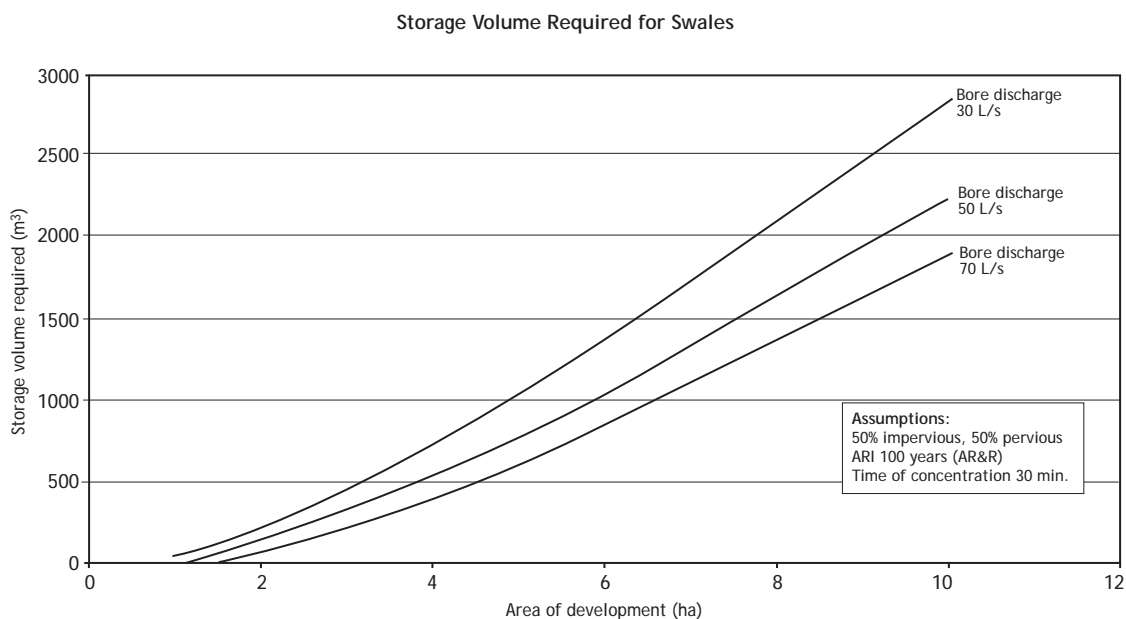

Figure 20 Minimum length of swales (1-in-1 year)

### Example

For a 4 ha development with a longitudinal slope of 2%, the minimum length of swale for a 1 m base width and side slopes of 5H:1V is approximately 175 m.

For larger storm events the swale must provide sufficient storage capacity to fully contain the volume generated. The following curve (Figure 21) can be used to estimate the storage volume required to fully contain the maximum volume generated during a 1-in-100-year event (based on varying AR&R rainfall intensities for Mount Gambier) for varying development sizes. The curve assumes that the swale discharges to a bore with capacities ranging from 30 to 70 L/s.



**Figure 21** Storage volume required for swales discharging directly to a bore (1-in-100 year)

**Example**

For a 4 ha residential development with a longitudinal slope of 2%:

- The minimum storage volume required to fully contain a 1-in-100-year event for a swale discharging to a bore with a capacity of 50 L/s is approximately 550 m<sup>3</sup>.
- The design curves presented are intended for planning purposes, and the planning authority will approve final engineered swale designs.

**Construction**

- Care should be taken during construction to ensure that the channel bed is not compacted, which would reduce the vegetation growth and infiltration capacity.
- Swales should not receive runoff until they are fully vegetated and all scour protection measures have been implemented.
- Typical details for the construction of swales are shown in Figures 22 and 24.

**Maintenance**

- Primarily, maintenance should be aimed at preserving a dense grass or vegetative cover over the swale, and should include routine inspection, watering, weeding and reseeding as necessary.
- Swale effectiveness is enhanced by maintaining grass height at 75 mm or greater.
- Erosion of swales should be repaired when required.
- Built-up sediment, debris and litter should be removed from the swale surface.
- Pesticides and herbicides should not be used in the swale area.

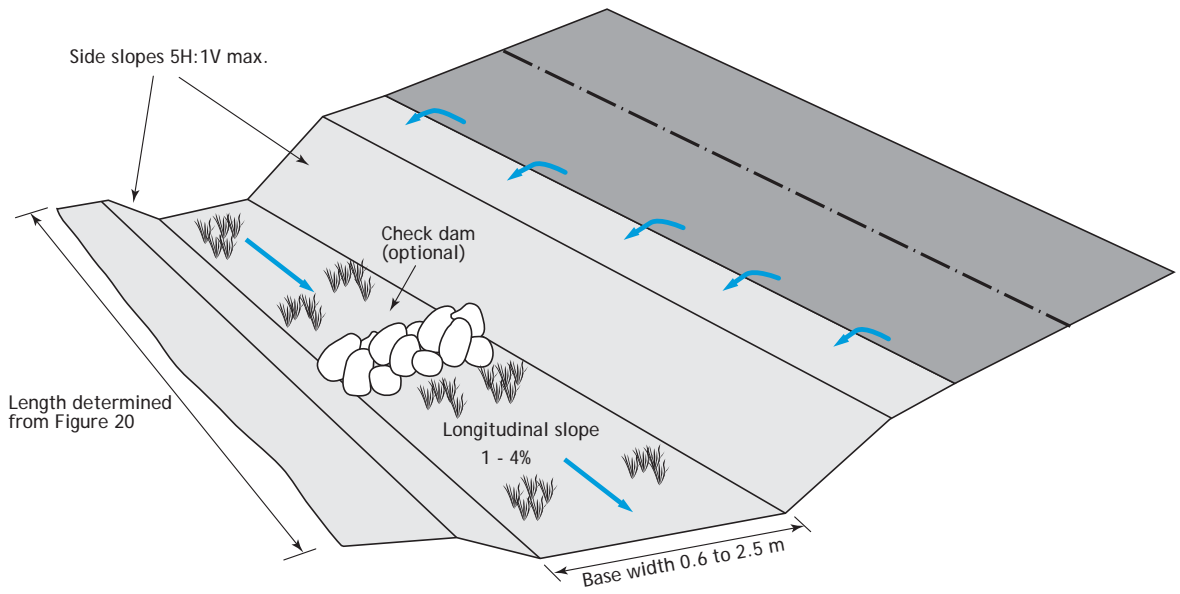

Figure 22 Typical swale details

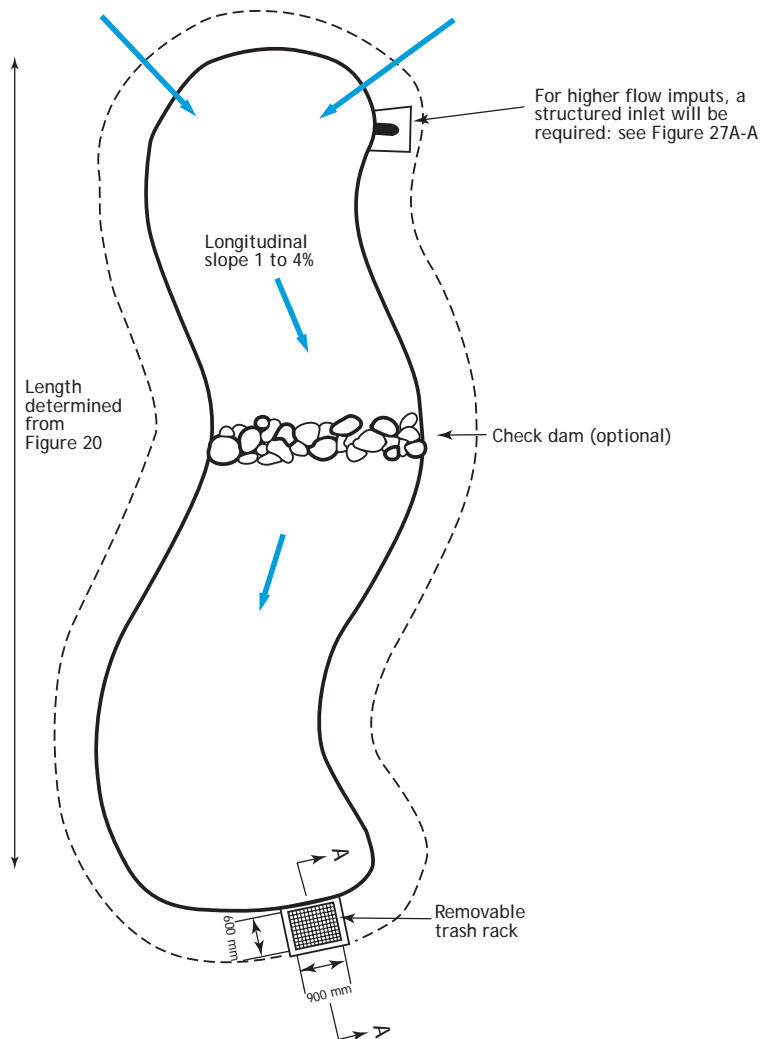

Figure 23 End of swale detail discharging to a bore

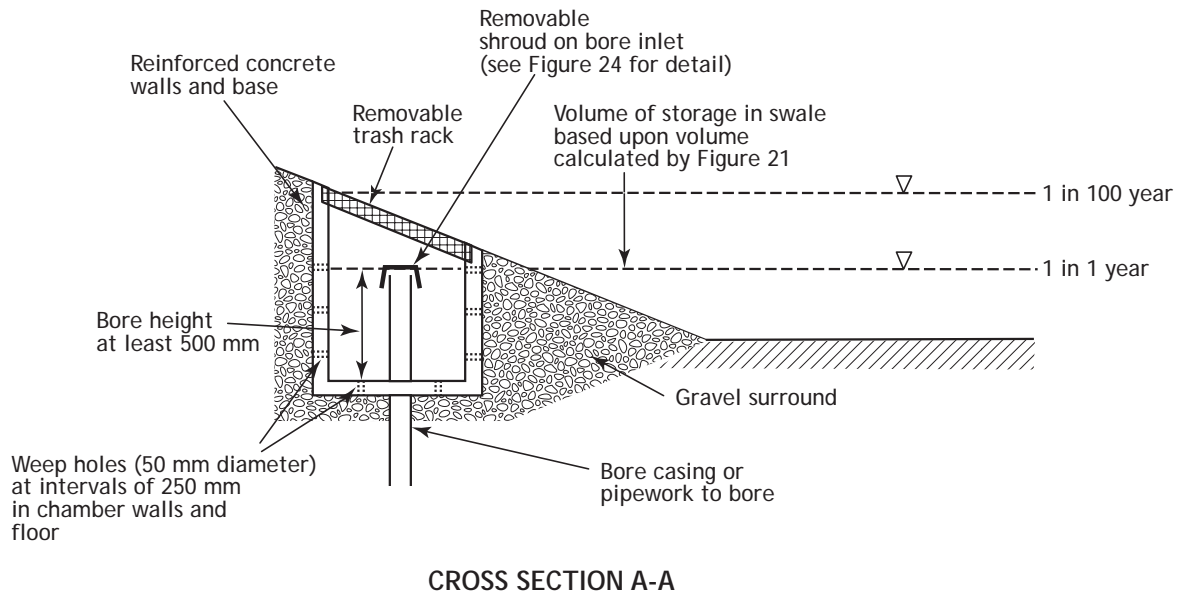

Figure 23 (cont) End of swale detail discharging to a bore

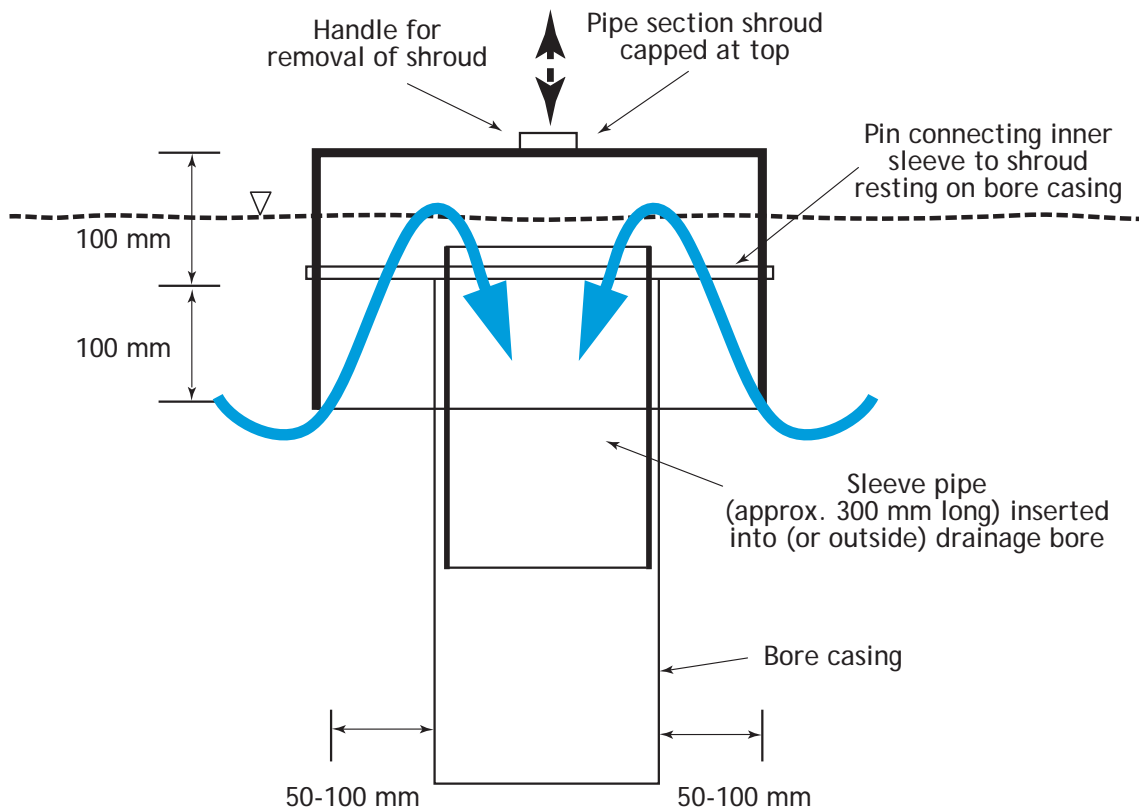

Figure 24 An option for bore protection from floating substances using a removable shroud

## Retention basins

### Description

Retention basins are designed to temporarily store runoff for periods no greater than approximately 1 day before draining either by infiltration and/or drainage wells. They are used primarily for flood protection but also allow for pollutant removal through sedimentation and infiltration.

### Typical applications

Retention basins are most applicable for larger developments (>5 ha). Basins can be sized to suit local conditions and can be incorporated within developments to achieve a multipurpose benefit, including:

- recreational use
- aesthetics
- incorporation of small permanent ponds
- improvement of property values
- incorporation of swales and gravel trenches into the floor of the basin for more efficient contaminant removal.

Some examples in use in Mount Gambier are shown in Figures 25 and 26.

### Limitations

- They require large land areas.
- They cannot be placed on steep slopes, fill or unstable areas.
- Clogging of the basin floor may occur over time, reducing infiltration capacity.

### Design

- The soil infiltration capacity is a key design factor that should be established at each potential site; in-situ infiltration tests, as described in Appendix A, should be performed to determine the soil infiltration capacity at the surface.
- If the basin is capturing stormwater from a catchment area greater than 5 hectares, a site-specific soil investigation is needed to identify any sub-layers that have a low permeability. This assessment will need to document these sub-layers, and determine if they could affect stormwater infiltration.



Figure 25 Retention basin with gravel trench floor and gravel surround at bore



Figure 26 Large shallow basin incorporating swales

- The inflow into the basin should be spread over a large area.
- If sediment loads are expected to be high, pre-treatment measures for sediment and gross pollution should be incorporated.
- The basin floor should be relatively flat.
- Inflow velocity should be minimised and outlet protection used on basin slopes where required.
- Vegetation should be provided throughout the basin to help filter stormwater, particularly at the inlets to the basin.
- Basin floors and sides should be grassed to reduce erosion and the risk of fine sediment clogging the basin floor; grass species used should be suitable for frequent inundation.
- To permit mowing, side slopes should be 5H:1V maximum.
- A shallow basin depth (1-2 m) is usually sufficient.
- Vehicle access should be provided where necessary.
- A gravel surround to the discharge bore should be provided.
- A shroud and trash rack should be provided at the discharge bore chamber inlet.
- Typical details of retention basins for new developments are shown in Figure 27.
- Basins are designed to operate as two-stage devices—flows up to a 1-in-1-year event will drain via infiltration only (for water quality purposes based on continuous modelling for an average rainfall year using MUSIC software (CRC for Catchment Hydrology 2002), and larger flows will drain via the discharge bore; in high-risk flood areas a second bore may be required.
- The basins are to be sized to fully contain a 1-in-100-year event; the following charts in Figure 28 can be used to determine the level of the bore and the volume of the basin required to fully contain a 1-in-100-year event for varying residential development sizes; the following assumptions have been made:
  - AR&R rainfall intensities for Mount Gambier (Pilgrim 1987)
  - an infiltration rate of 36 mm/hr (typical for sandy clay/sandy loam soils)
  - assumed development of 50% impervious and 50% pervious for new residential developments
  - basin side slopes of 5H:1V
  - a bore capacity of 50 L/s<sup>1</sup>.
- As several assumptions (based on typical conditions that could be expected in Mount Gambier for a new residential development) must be made to develop the curves in Figure 28, the curves presented for sizing retention basins are intended for planning purposes only; the planning authority must approve final engineered retention basin designs incorporating site-specific data.
- The development of the curves in Figure 28 is based on AR&R rainfall intensities for Mount Gambier, together with the storm duration that results in the maximum pond volume. The user should be aware that this method is based on standard practice using AR&R criteria and does not take into account retained volume before the onset of the storm, although a maximum draindown of 24 hours is chosen for design; continuous modelling using actual or simulated rainfall based on the statistical properties of the historic rainfall record will allow prior storages to be modelled.
- The depth of soil in the features must be at least 300 mm to provide a growth media for vegetation, and to filter any pollutants.

---

<sup>1</sup> The assumed bore capacity in these examples must be used with extreme caution. Although capacities of 50 L/s are common in the Mount Gambier area, there are locations where capacities as low as 4 L/s are reported. Individual sites should endeavour to research bore capacities in the surrounding areas.

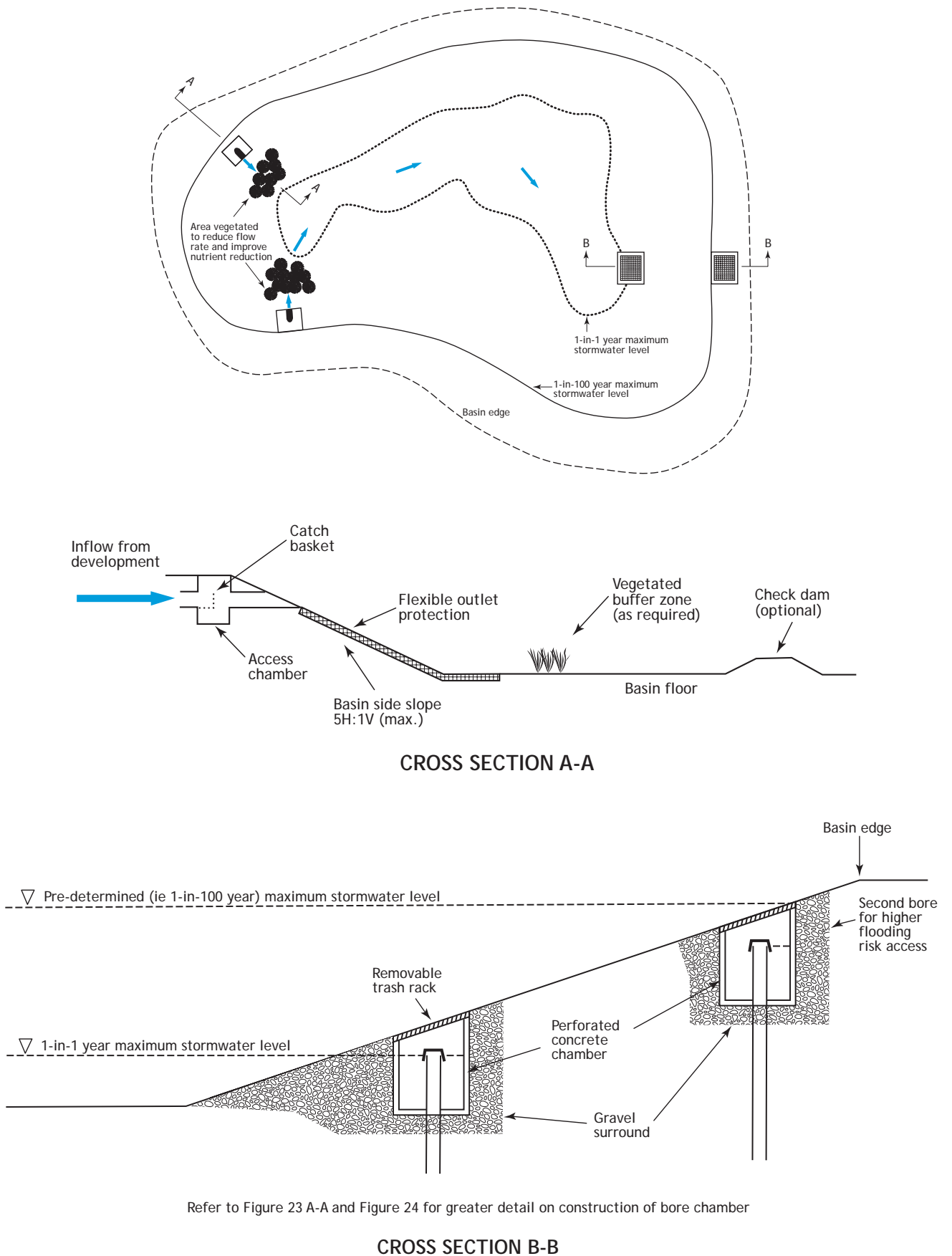

Figure 27 Retention basin details

### **Construction**

- Basins should not receive construction sediment loads; where sediment does accumulate, this material should be removed before basin operation.
- Light construction plant should be used to minimise soil compaction of the basin floor.
- At the end of construction of the basin, the floor should be tilled and levelled.
- The basin should not become operational until it is fully established.

### **Maintenance**

- Maintenance should be regular and include periodic removal of built-up sediment, grass mowing and repair of areas affected by erosion.
- Inspection of the basin following storm events should be undertaken to observe draindown times; increasing draindown times and the presence of ponded water will indicate a reduction in infiltration rates.
- Periodic tilling may be required to improve the infiltration capacity of the basin.
- Pesticides and herbicides should not be used in the detention basin.

Retention basin size for 5 ha development  
ARI 1 Yr

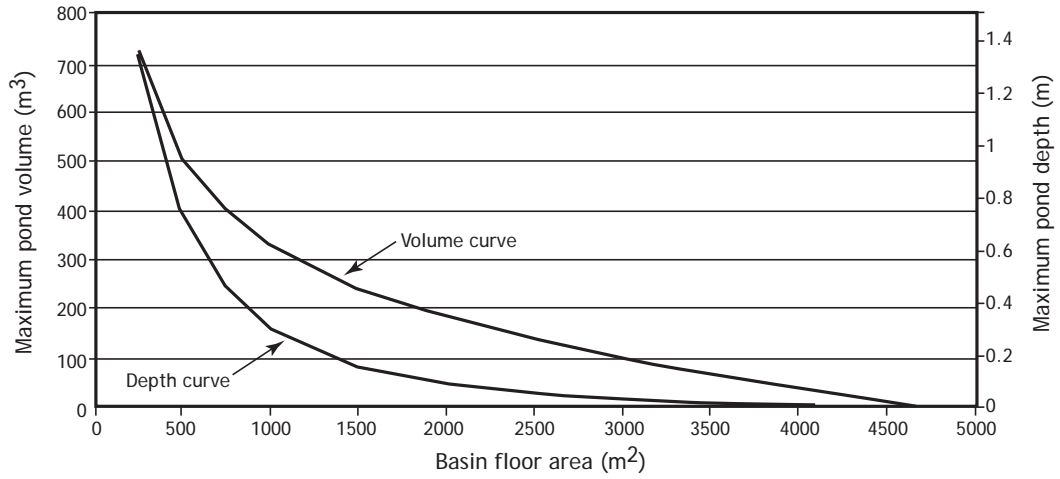

**Assumptions:**  
 50% impervious, 50% pervious  
 AR&R rainfall intensities  
 Time of concentration 60 mins  
 Seepage rate of 36 mm/hr  
 Bore capacity of 50 L/s  
 Basin side slopes of 5H:1V

Retention basin size for 5 ha development  
ARI 100 Yrs

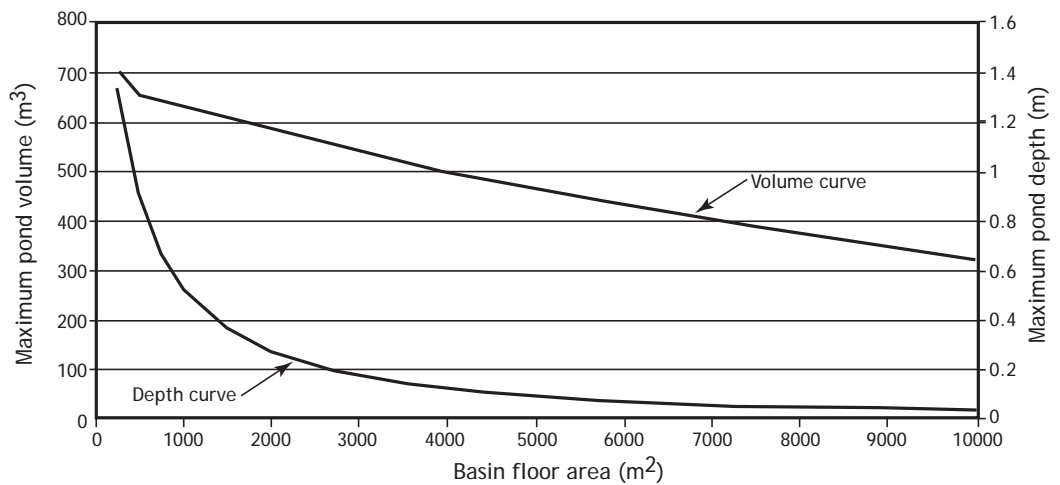
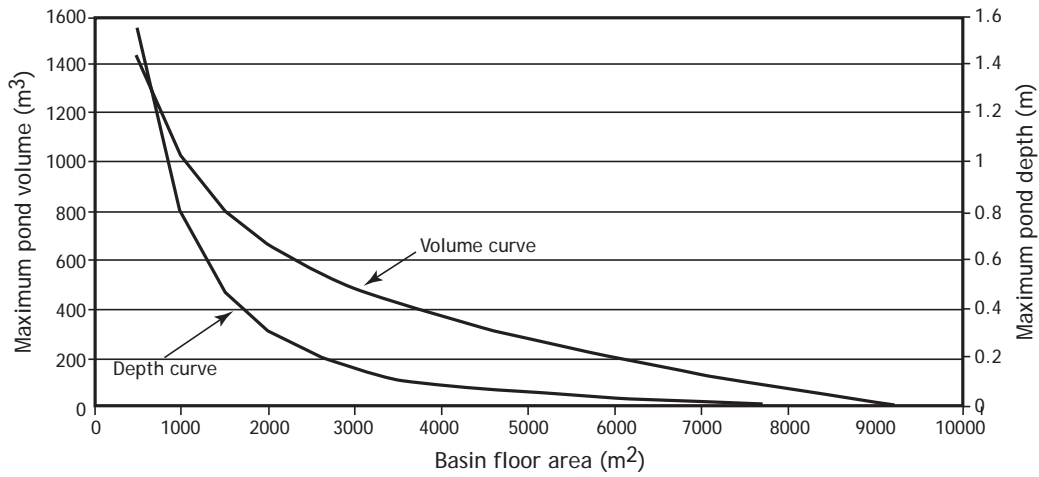

Figure 28 Retention basin preliminary sizing charts

### Retention basin size for 10 ha development ARI 1 Yr



**Assumptions:**  
 50% impervious, 50% pervious  
 AR&R rainfall intensities  
 Time of concentration 60 mins  
 Seepage rate of 36 mm/hr  
 Bore capacity of 50 L/s  
 Basin side slopes of 5H:1V

### Retention basin size for 10 ha development ARI 100 Yrs

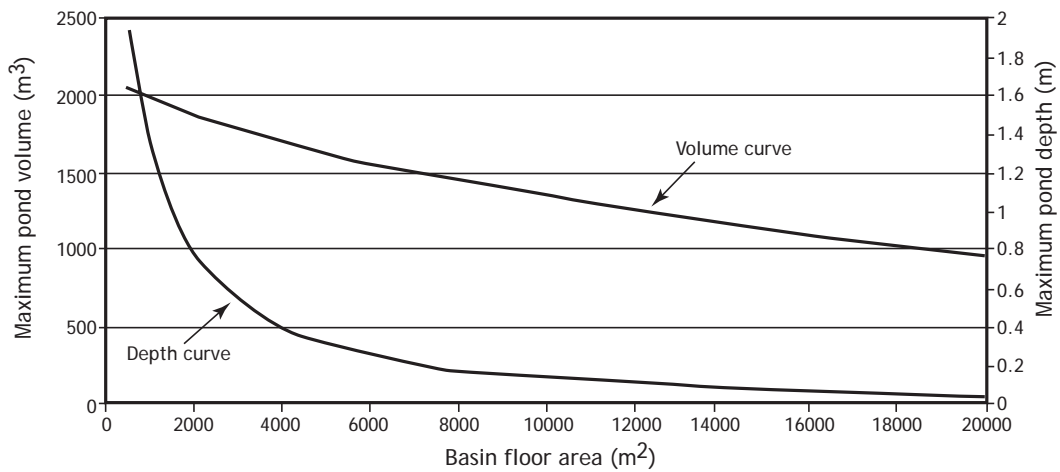
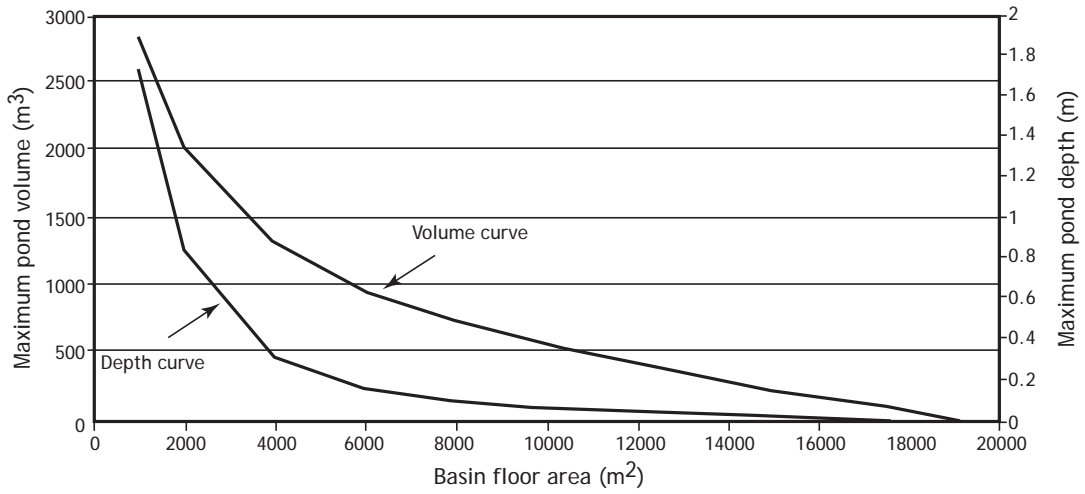

Figure 28 (cont) Retention basin preliminary sizing charts

Retention basin size for 20 ha development  
ARI 1 Yr



**Assumptions:**  
 50% impervious, 50% pervious  
 AR&R rainfall intensities  
 Time of concentration 60 mins  
 Seepage rate of 36 mm/hr  
 Bore capacity of 50 L/s  
 Basin side slopes of 5H:1V

Retention basin size for 20 ha development  
ARI 100 Yrs

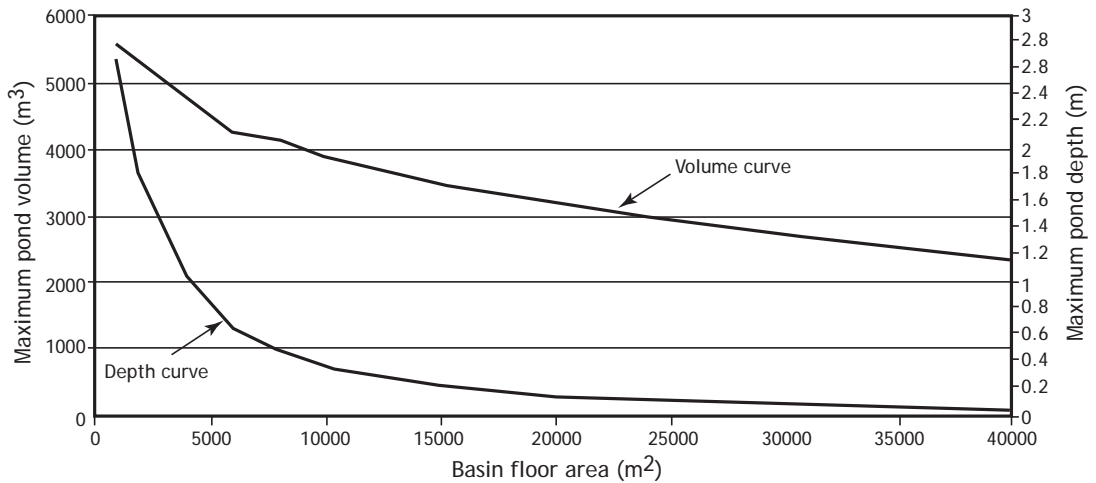
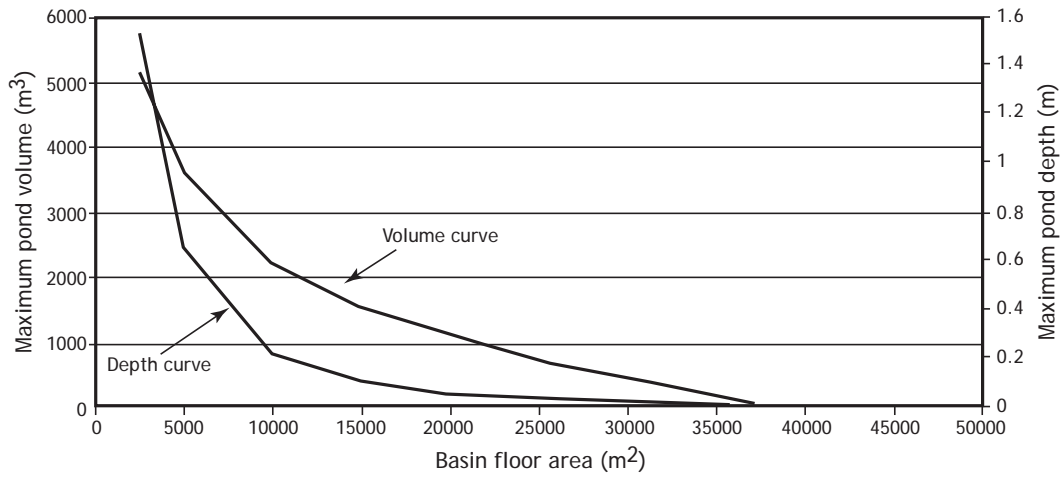

Figure 28 (cont) Retention basin preliminary sizing charts

### Retention basin size for 40 ha development ARI 1 Yr



**Assumptions:**  
 50% impervious, 50% pervious  
 AR&R rainfall intensities  
 Time of concentration 60 mins  
 Seepage rate of 36 mm/hr  
 Bore capacity of 50 L/s  
 Basin side slopes of 5H:1V

### Retention basin size for 40 ha development ARI 100 Yrs

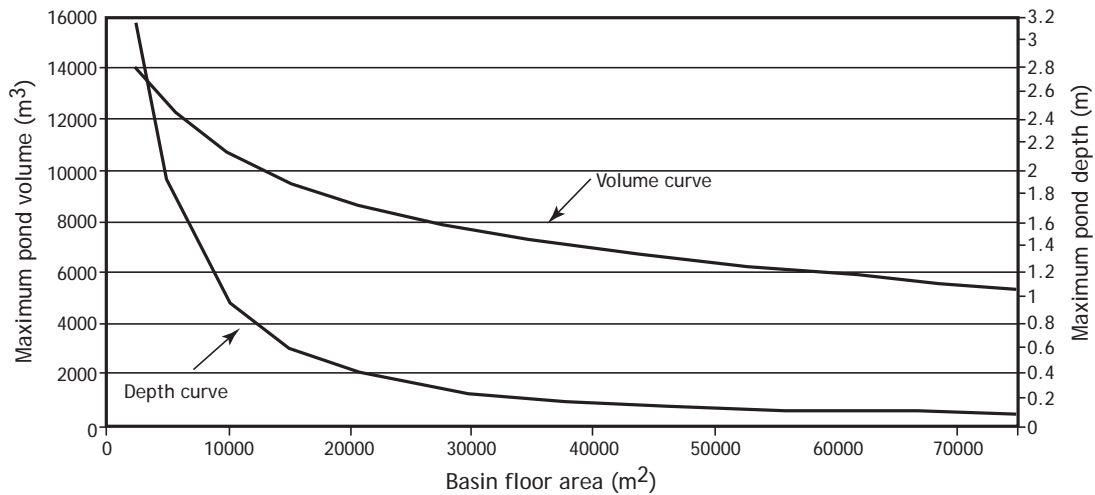

Figure 28 (cont) Retention basin preliminary sizing charts

### Example

For a retention basin required to serve a 40 ha development, an initial basin size of 5000 m<sup>2</sup> is proposed by the developer. The following can be determined from Figure 28:

- The maximum pond volume and pond depth for a 1-year ARI are approximately 3600 m<sup>3</sup> and 0.65 m respectively.
- The maximum pond volume and pond depth for a 100-year ARI are approximately 12,500 m<sup>3</sup> and 1.9 m respectively.

In the case where a 1.9 m depth is considered too deep, the curves can be used to select a basin area based on a maximum pond depth. For example, should the depth be limited to 1.5 m, then an area can be selected based on the maximum pond depth during a 1-in-100-year event. In this case, assuming a 300 mm freeboard, the maximum pond depth for a 1-in-100-year event is 1.2 m. The following can then be determined from Figure 28:

- The basin floor area for a 1.2 m maximum pond depth for a 100-year ARI is 8400 m<sup>2</sup>.
- The maximum pond volume and pond depth for a 1-year ARI are approximately 2500 m<sup>3</sup> and 0.32 m respectively.

The discharge bore level would thus be set at just above the 1-year ARI maximum pond height, i.e. 0.32 m, and the depth of the basin must be at least 1.2 m plus an appropriate freeboard to contain a 1-in-100-year event.

If there is an overflow path then no freeboard is required in the retention basin.

## Storage tanks

### Description

Storage tanks are used for collecting rainwater. They can be above- or below-ground installations and typically receive roof runoff. These systems can reduce the quantity of stormwater entering the stormwater system and may provide a clean source of water for recycling on site.

### Typical applications

These are typically used at a residential allotment level in the form of above-ground rainwater tanks to collect roof runoff. Other systems available at residential allotments include enlarged box gutters to provide storage at the eaves level and modular fencing with storage incorporated into the fence system. At a commercial and industrial level, underground tanks are commonly used. These can be constructed from reinforced concrete, fibreglass or heavy duty plastic. A typical example of a rainwater tank for a residential allotment is shown in Figure 29.

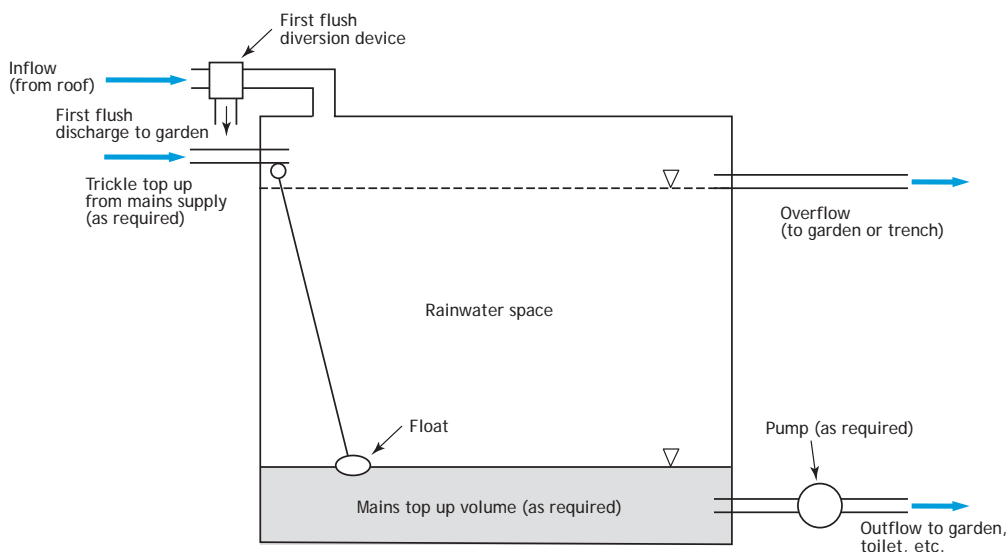

Figure 29 Rainwater storage tank

## Limitations

- They will only provide storage capacity if the stored water is used for purposes such as irrigation and in-house use (e.g. toilet flushing, etc.).
- It is usually difficult to direct all roof runoff from a residential lot to a single downpipe connecting to an above-ground rainwater tank.
- They may not be suitable as a potable source of water in areas where collected runoff is contaminated from sources such as lead and tar based paints on roofs, asbestos or atmospheric pollution.
- Underground tanks can be subject to contamination from surface runoff or accidental cross-contamination from septic tanks.

## Design

- Above-ground tanks should be fitted with a first flush device to divert the initial runoff from the roof away from the tank.
- Screens should cover all inlets and outlets to reduce the chance of entry of leaves, debris, animals and mosquitoes.
- An overflow must be provided; overflow water can be directed to gravel filled trenches before discharging to the stormwater system.
- Rainwater tanks can be provided with a slow release mechanism which can direct stored water to garden areas.
- Rainwater tanks may be interconnected with the mains water supply to the house, provided an approved residential dual check-valve is installed above ground on the mains water service before the connection with the tank. This is needed to avoid any possible backflow from the rainwater tank into the mains supply. Further advice on these valves is available from SA Water.
- Typically, above-ground rainwater tanks are 2 to 20 k/L in size and can yield 20 to 150 kL/yr.
- Enlarged gutters typically store 1-2 kL, the storage capacity depending on the cross-sectional area and length of gutter.
- Underground storage pits should be located away from heavily trafficked areas to enable easy maintenance; circular lids are preferred as they are less likely to accidentally fall into the pits.
- For pits capturing runoff from paved surfaces, gross pollutants must be prevented from entering the pits; it is also preferable to remove sediments from the runoff prior to its entering the pits.
- Small pumps may be required to deliver water for reuse from above- and below-ground installations.
- Water stored in enlarged gutters can be directed to the house without the need for pumping.
- Many systems are proprietary built; all manufacturers' recommendations should be followed.
- The following curves (Figure 30) can be used to determine the average annual supply using rainwater tanks for varying combinations of roof area, daily demand and tank size. The assumptions are listed in the figure.

## Construction

- A licensed plumber should be employed for installation.
- Manufacturers' recommendations should be adhered to.

## Maintenance

- Tanks should be flushed out annually.
- Gutters and first flush devices should be cleaned regularly.
- Leaks should be repaired as required.

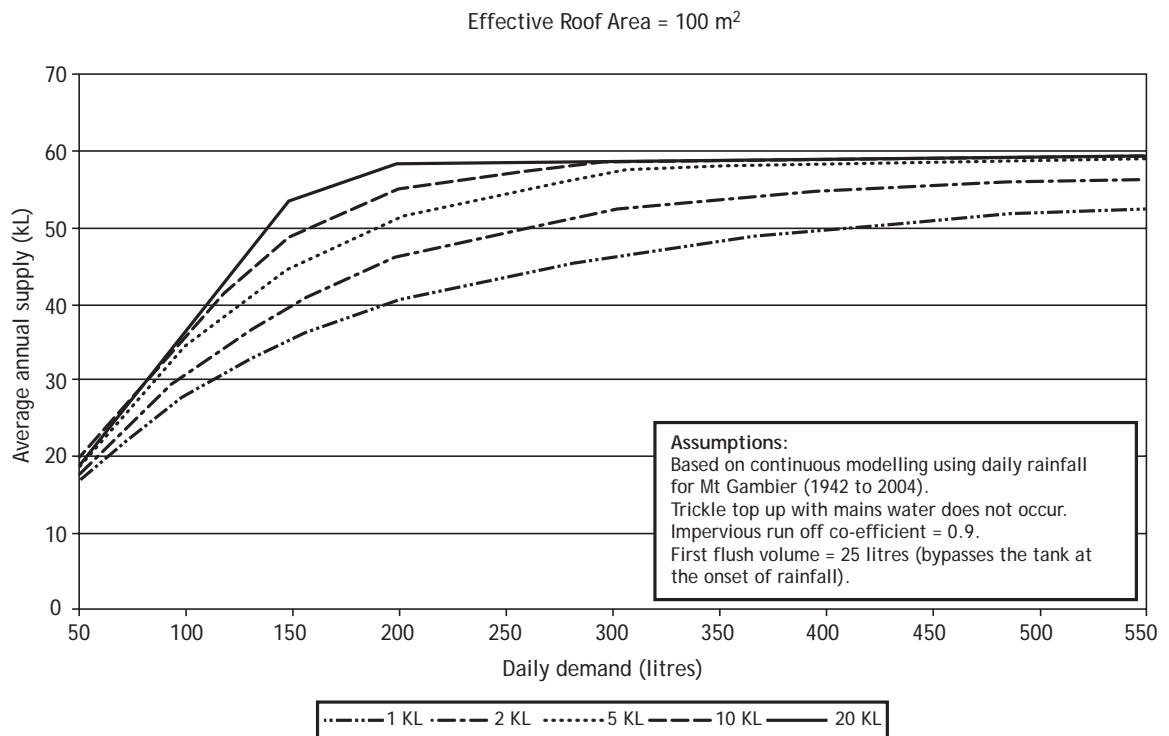
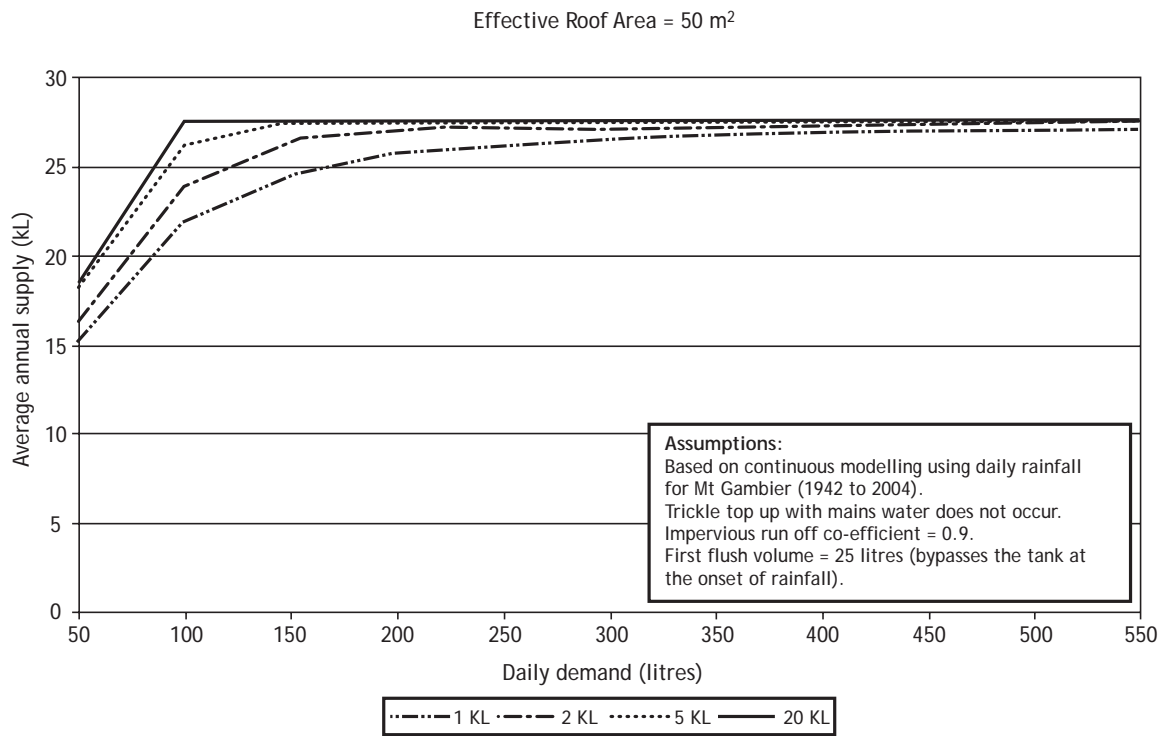

Figure 30 Rainwater tank yield curves for Mount Gambier

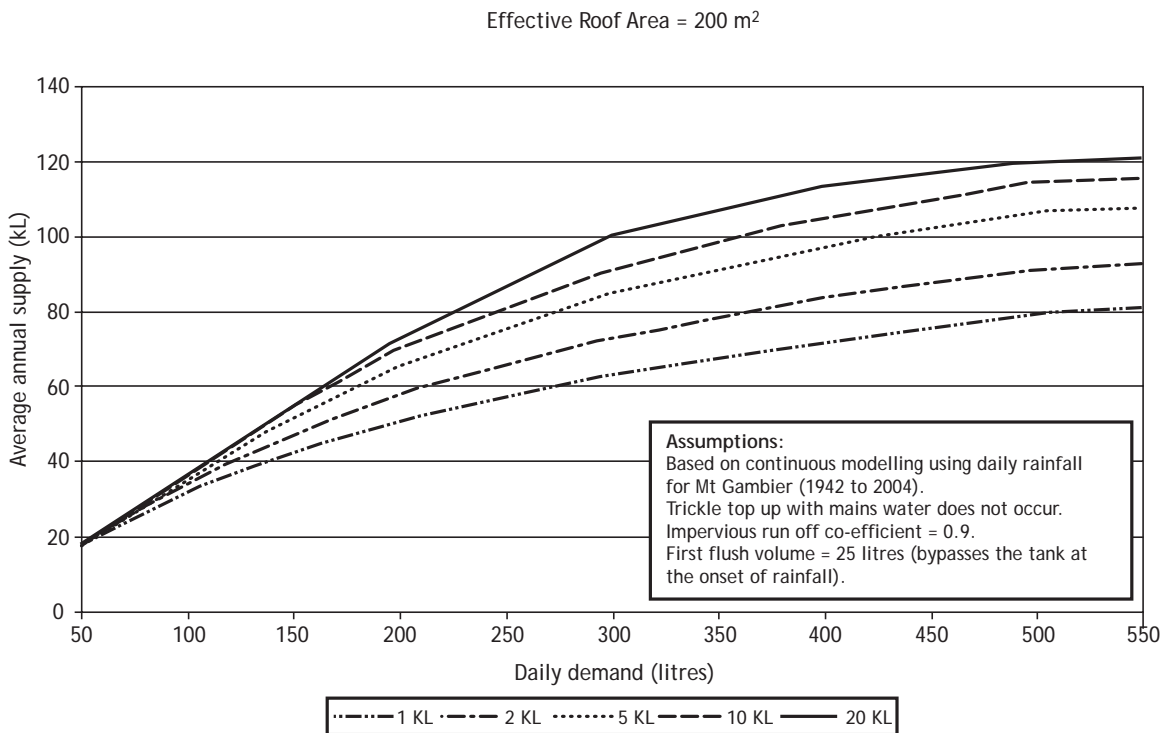
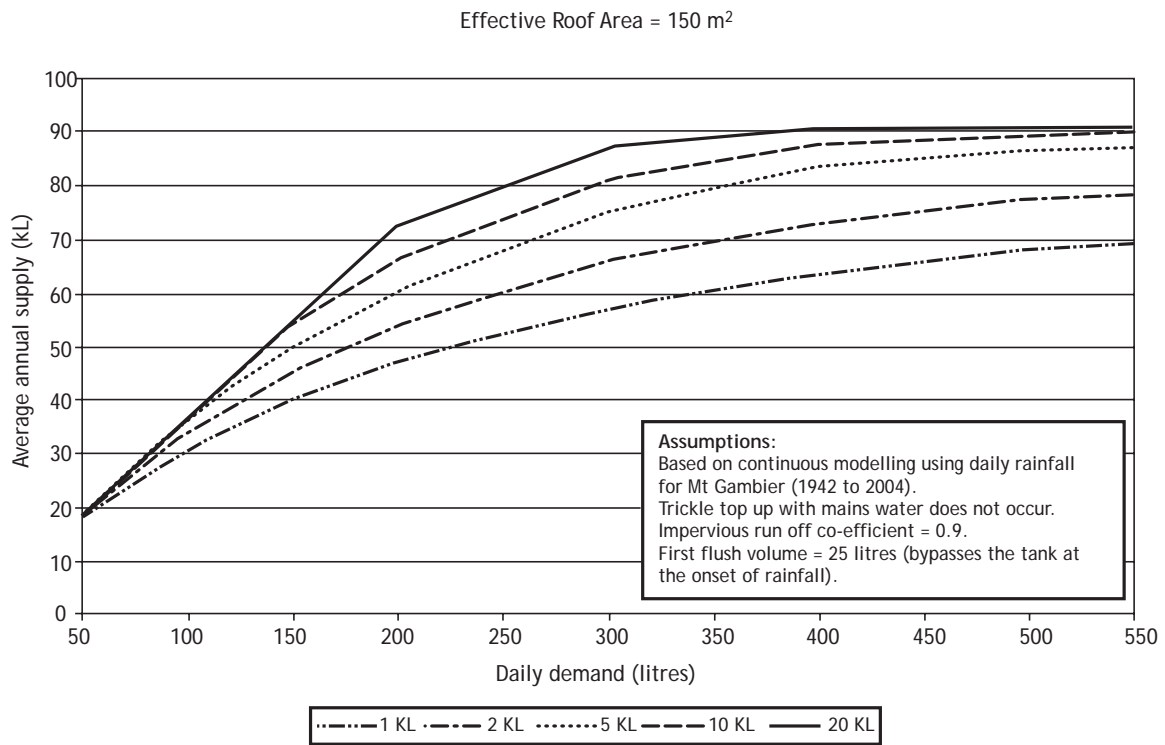

Figure 30 (cont.) Rainwater tank yield curves for Mount Gambier

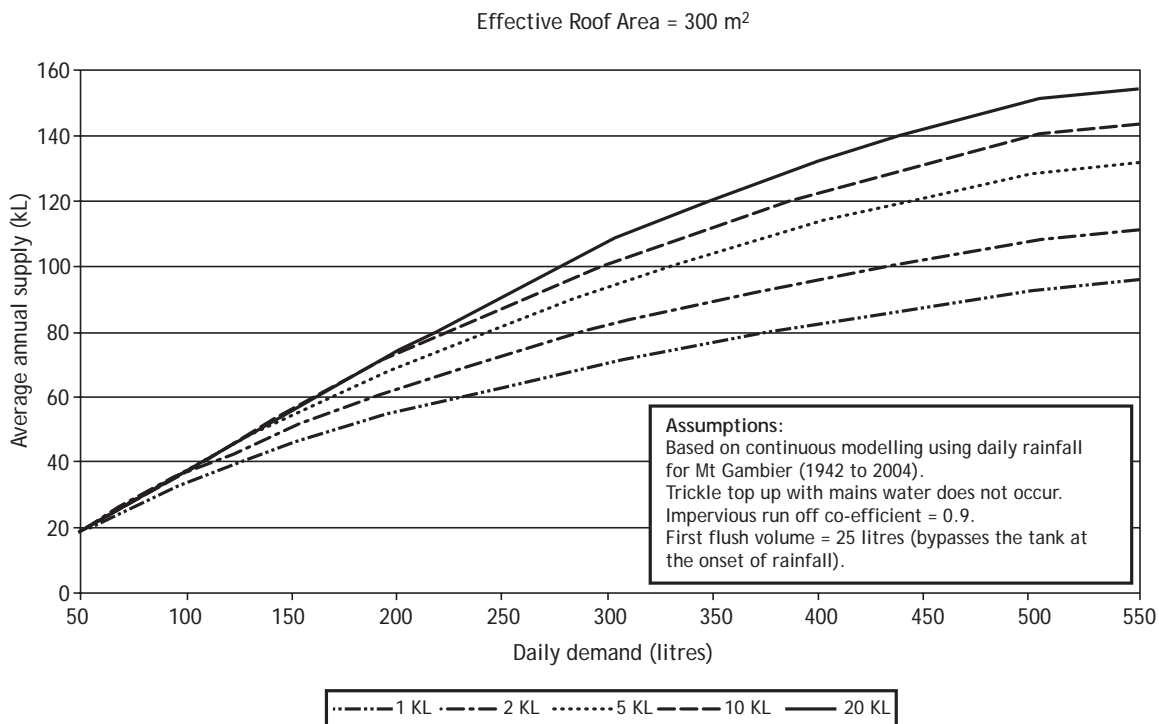
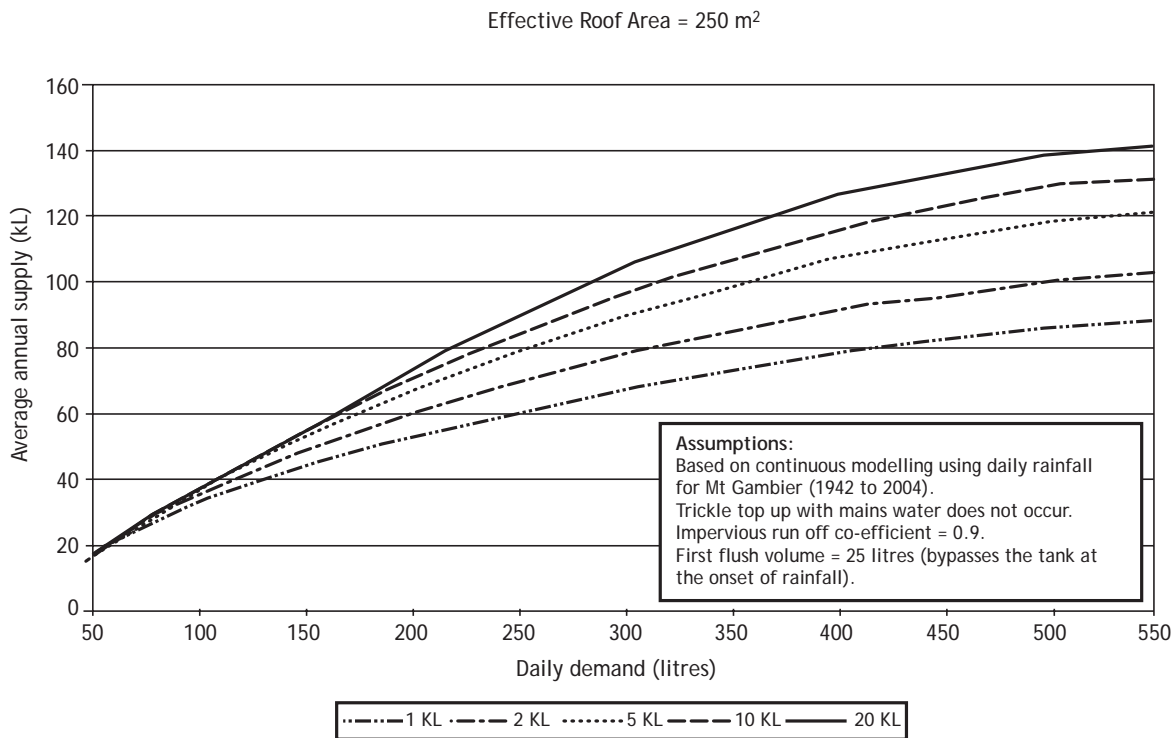

Figure 30 (cont.) Rainwater tank yield curves for Mount Gambier

### Example

- Total roof area = 350 m<sup>2</sup>
- Total roof area connected to tank (effective roof area) = 200 m<sup>2</sup>
- Rainwater tank size = 10 kL
- Daily demand = 250 litres
- Estimated average annual supply (from Figure 30) = 80 kL

## Hydrocarbon interceptor and containment tanks

### Description

Interceptor and containment tanks are used where hydrocarbon contamination could occur. Containment of potential leaks or spills will prevent the contaminants entering the groundwater system. These systems do not discharge to the stormwater system, but are either retained for off-site transport or discharged to the sewer.

### Typical applications

Typically, these systems are used at service stations or refuelling areas.

### Limitations

- They have a limited capacity to contain leaks and spills.

### Design

- At service stations separate paths must be provided for fuel spills and stormwater.
- An interceptor tank must be provided under the roofed refuelling area.
- The floor under the roof must be sloped toward the interceptor tank.
- For accidental spills from road tankers, a further retention tank must be provided with capacity to contain one compartment-load of a road tanker in a separate area of the service station before discharge to the stormwater system.
- For in-ground storage tanks the double containment management approach should be used (see below).

### Construction

- In-ground storage tanks are placed in large concrete tanks, which are then backfilled with sand (double containment approach); piezometers can be placed in the backfilled sand to monitor for leaks.
- Above-ground tanks can be surrounded by bunkers to provide full containment of fuel in the event of failure.

### Maintenance

- Piezometers should be monitored for leaks, and repaired as required.
- Periodic removal of collected spills and sediments should be carried out as required.

## Manufactured units with hydrocarbon separators

### Description

In recent years there has been improvement in the technology used to manufacture units with hydrocarbon separation systems to remove residual hydrocarbons from stormwater before discharge. There are various product brands available, each system generally including a storage reservoir, a pre-filter and a hydrocarbon separator. These systems require a high degree of maintenance but can be very effective in areas where the presence of a higher than usual amount of hydrocarbons is expected.

They are produced in a range of sizes to meet catchment and flow demands. The photograph below (Figure 31) illustrates an example of a manufactured unit with hydrocarbon separator installed in Mount Gambier.

### Typical applications

Typically, these systems are used for large vehicle parking areas where there is an increased risk of hydrocarbons in stormwater.

### Limitations

- They have higher capital and maintenance costs.

### Design

- The separation device is normally installed below ground level and in a location that is accessible and allows gravity flow into the device.
- The installation of flow delay systems may be required to reduce the magnitude of stormwater flow entering the device.
- Access must be readily available to the device to allow for inspections, pump-outs in the case of spills, and replacement of filters as necessary.

### Construction

- The devices are placed into the ground and then backfilled with sand.
- The devices are usually very robust and do not generally require double insulation.
- Installation is very much directed by the manufacturer's specifications and directions, and is often device specific.

### Maintenance

- Periodic inspection and replacement of filters is necessary to maintain a good level of performance.
- Removal of sediment and litter should also occur regularly.



Figure 31 Manufactured unit ready for in-ground installation

## **Innovative solutions**

The developer is not restricted to the measures listed previously and may propose the use of innovative solutions. Such proposals must be submitted to the planning authority for approval. It must be demonstrated that the measure or measures proposed achieve the target removal rates as listed in Table 1. Typically, this can be demonstrated using industry software such as MUSIC (CRC for Catchment Hydrology 2002). Continuous modelling using Mount Gambier rainfall data for 1988, which is considered to represent a typical rainfall year, is to be used; this rainfall data can be purchased from the Bureau of Meteorology. Rainfall at 6-minute intervals is preferred to accurately model most treatment measures.

## 10 SUMMARY OF APPLICABILITY OF STORMWATER METHODS

Based on the previous chapters, it is clear that there are a variety of options that can be considered for different sites. In summary, Table 9 provides guidance on the types of stormwater treatment methods that should be considered for the main types of developments. As discussed earlier, it is likely that more than one stormwater management method will be used at each site.

**Table 9 Summary of structural treatment measures for Mount Gambier**

Type of development	Possible actions
New residential	<p>Incorporate water-sensitive urban design principals described in Figures 5 to 12</p> <p>Rainwater tanks with first flush</p> <p>Infiltration trenches/soak-aways at overflows to rainwater tanks or use as stand-alone systems directly connected to roof runoff</p> <p>Permeable paving in appropriate locations</p> <p>Kerblin filter strips</p> <p>Swales in developments less than 5 ha</p> <p>Retention basins with or without swales in developments greater than 5 ha</p>
New industrial/commercial	<p>On-site retention (above or below ground)</p> <p>Infiltration trenches/soak-aways at overflows to storage tanks or use as stand-alone systems directly connected to roof runoff</p> <p>Manufactured units with hydrocarbon separators for areas of higher than usual hydrocarbon presence</p> <p>Permeable paving in appropriate locations</p> <p>Grassed depression storage in carpark areas as per Figure 15</p> <p>Kerblin filter strips</p> <p>Swales in developments less than 5 ha, where appropriate</p> <p>Retention basins with or without swales in developments greater than 5 ha, where appropriate</p> <p>Hydrocarbon interceptor and containment tanks (at fuel storage locations)</p>
Roadway networks	<p>Incorporate water-sensitive urban design principals described in Figures 5 to 12</p> <p>Swales in developments less than 5 ha</p> <p>Retention basins with or without swales in developments greater than 5 ha</p> <p>Permeable paving in appropriate locations</p> <p>Kerblin filter strips</p> <p>Manufactured units with hydrocarbon separators for areas of higher than usual hydrocarbon presence</p>

## 11 CONSTRUCTION OF STORMWATER DISPOSAL BORES

As discussed, in some sites there will be a need to install a stormwater bore for disposal. The design and construction of stormwater disposal bores needs to be undertaken in a certain manner to minimise the risk of groundwater contamination. As a guide, all stormwater disposal bores will need to include the following.

- Stormwater disposal bores will need to be clearly marked and identified by permanent signs.
- Stormwater disposal bores and headwork(s) will need to be accessible at all times.
- Stormwater disposal bores will need to be constructed to include physical barriers to protect the bore and headwork(s) from damage by vehicles (bores should preferably be located away from vehicle traffic-ways and roads).
- Any bore construction or alteration will need to be undertaken in a manner consistent with the relevant provisions outlined in the *Water Resources Act 1997* and the 'Minimum Construction Requirements for Water Bores in Australia' (Agriculture and Resource Management Council of Australia and New Zealand 1997 ISBN 0 7242 7401 4).
- Stormwater disposal bores will require testing once constructed to ensure that the discharge rates (amount of water able to be disposed of down the bore per unit time) are within the design criteria of the treatment and retention systems.

All stormwater disposal bores need to be constructed to incorporate contingency and protection measures in response to emergency situations. The types of measures taken will depend on the bore location and circumstances. Stormwater bores that will come under the control of the local council will need to match the council established procedures. On private properties other methods such as isolation valves should be considered.

The Water Resources Act requires that a bore construction permit be obtained before any drilling, rehabilitation or backfilling of bores. The Department for Water, Land and Biodiversity Conservation should be contacted to discuss the approvals that are needed under the Water Resources Act.

A licence or permit may also be required to discharge stormwater into any discharge bore, depending upon the location. The Environment Protection Authority and the Department for Water, Land and Biodiversity Conservation should be contacted to identify the specific requirements for ongoing discharge authorisations.

## 12 PLANNING FOR MAINTENANCE AND MONITORING

As recognised throughout this document, the ongoing performance of stormwater treatment and management systems is heavily dependent on the regular maintenance and monitoring of the systems; these stormwater systems are not self-cleaning nor 'set and forget'.

The resourcing, responsibility and manner of monitoring and maintenance must all be considered during the early stages of planning stormwater options for a site. Although in some developments the infrastructure ownership and responsibility for maintenance may rest with the site owner, there are other developments such as new residential areas, precinct developments or infill developments where the land management agreements may be established with the council. To ensure that the system maintenance requirements are acceptable, the developer should have early discussions with the local council about the options for longer-term management of stormwater treatment systems or discharge bores.

In order to document the requirements for monitoring and maintenance, as well as to clearly define the responsibilities for coordinating this work, a maintenance and monitoring plan needs to be developed during the planning stages and provided along with the documentation for planning approval. The considerations that should be made in developing this plan are discussed below.

### Monitoring

The type of monitoring required to keep the performance of the stormwater system under review will depend greatly upon the type of system constructed. Although monitoring may, in some cases, include the collection of stormwater samples being discharged to bores or off site, many other forms of monitoring can be effective. Types of monitoring that should be considered are:

- visual inspections of traps and areas of potential gross pollutant build-up every two to four months
- inspection of soil and vegetation within and around the stormwater treatment system for the early identification of erosion, scouring or potential erosion that may result in transport of significant sediment loads through the stormwater treatment system
- visual inspections of manufactured units or proprietary devices at the frequency suggested by the manufacturer (there is a need to specify the frequency period in the plan).

Obviously, the frequency and combination of monitoring methods will depend on the circumstances in the catchment. For instance, a gross pollutant trap near a shopping centre may collect a substantial amount of litter and may need more regular checking than a trap in a small residential area. The frequency and scope of monitoring should be based on the identified level of risk.

### Maintenance

This guideline highlights the issues that require specific maintenance focus for each of the structural stormwater methods (see individual Maintenance headings in Chapter 9), and this work obviously needs to receive appropriate attention. Although the frequency of some of the maintenance will depend on the outcomes of the monitoring, regular maintenance will be needed on some systems (such as weed control in basins and swales). For both the regular and irregular maintenance, it is important that ongoing resourcing provisions are made to ensure that when required, maintenance can be undertaken in a timely fashion.

The maintenance section of the plan therefore needs to outline the methods of expected maintenance for the system, as well as establishing the processes for ensuring that maintenance is undertaken effectively.

All maintenance and monitoring should be recorded in a log book as a permanent record of the performance of the system.

### **Responsibility**

The monitoring and maintenance plan must also identify the organisation or individual (if privately owned) who will be responsible for the monitoring, maintenance and management of the stormwater treatment system. If management of the stormwater systems is likely to come under the control of the local council, the plan must outline when this will occur (e.g. 12 months after all stormwater systems are constructed and commissioned). In these circumstances, it is strongly suggested that developers discuss their plans with the local council before finalising and submitting development applications. Although the monitoring and maintenance plan should detail whether the local council supports responsibility arrangements, it is not necessary to include a signed statement from the local council.

## 13 DOCUMENTATION FOR PLANNING APPLICATIONS

Through the development of the stormwater management proposal for the site, the landowner will need to have undertaken an assessment to ensure that the system being implemented achieves the principles and objectives as discussed in section 4.

Once the proposal has been submitted to the planning authority, usually the council, the council and/or the EPA will need to verify that the stormwater system is appropriate. To allow this to occur, the proponent needs to provide specific detail on the proposed stormwater management. Failure to provide this information may initially result in delays in the assessment process, as the information will need to be requested of the proponent.

In any development involving stormwater management, the proponent should ensure that the following information is included in the development application.

1. Details of the planning and structural methods that are proposed for the site to collect, direct, treat and dispose of stormwater at the site in a manner that achieves the performance criteria defined in section 5 of this guideline. This information should also include justification that the methods are appropriate for the site. Additionally, this information should include:
  - the design specifications and details of planning and structural methods for stormwater management
  - the data and information that was used to develop the dimensions and design specifications of the planning and structural methods (i.e. engineering calculation)
  - justification for any variation if the performance criteria defined in section 5 of this guideline are not achieved
  - if the technology is new or the existing data is not considered reliable, a detailed monitoring plan to assess the performance of the removal of hydrocarbons, SS, TP and TN (see Table 1).
2. A scaled plan(s) of the proposal site that includes the:
  - location of all bores on the site which are either existing or are proposed as part of the development
  - location of all structural stormwater treatment methods (devices)
  - location of all buildings on the site
  - location of all storage areas of chemicals or materials likely to degrade stormwater
  - location of any vehicle washing facilities, refuelling areas or bunded areas
  - location of any stormwater pipework
  - the delineation of the entire surface water catchment area for each catchment that exists within the site
  - extent to which runoff from the entire catchment will be included in each/all stormwater discharge bore(s), and whether or not the catchment area exists wholly within the proposed development site.
3. Details and scaled plans of the collection, treatment and disposal methods proposed for any domestic wastewater (from toilets, showers, kitchens or other similar activities) within the site. Usually, this type of wastewater stream should be directed to the sewer.
4. The details of construction, upgrade or rehabilitation of any bores at the site. This information should include details such as casing depths, bore hole depths and headworks, etc.

5. The details of all existing bores on the site, including:
- registered permit numbers (issued by the Department of Water, Land and Biodiversity Conservation)
  - geological logs
  - standing water levels
  - construction details including headworks.

Note: If not readily available, this information may be sourced from the Resource Assessment Division of the Department of Water, Land and Biodiversity Conservation.

6. A soil landscape description that includes:
- a description of the soil characteristics at the location of the stormwater treatment system (i.e. basin/swale) including the type and depth of soil, and estimated infiltration rates
  - the results of any assessment undertaken to identify subsurface layers with a low permeability
  - a Soil Erosion and Drainage Management Plan (as described in the Stormwater Pollution/Prevention Code of Practice for Local, State and Federal Government) that describes the manner in which stormwater will be protected during construction activities within the catchment area.
7. A monitoring and maintenance plan (as described in Chapter 12) that details:
- the organisation responsible for ongoing maintenance and management of the stormwater system
  - any performance monitoring that will be undertaken to demonstrate the effectiveness of the treatment systems
  - the maintenance plan that will be implemented to ensure ongoing effective operation of the stormwater system
  - the contingency plan that will be implemented at the site to prevent stormwater and groundwater contamination as a result of a spill or catastrophic event.

## 14 FURTHER READING

Argue JR, Allen MD, Greiger WF, Johnston LD, Pezzaniti D and Scott P, 2004, *Water-sensitive urban design: 10 basic procedures for source control of stormwater—A handbook for Australian practice*, First Edition.

City of Mount Gambier 1999, Stormwater Drainage Emergency Management Plan, Unpublished local government plan, 25 November 1999.

CRC for Catchment Hydrology 2002, *MUSIC model for urban stormwater improvement conceptualisation, Version 1.0*, Urban stormwater quality software.

CSIRO 1999, *Urban stormwater—Best practical environmental management guidelines*, Prepared for the Stormwater Committee.

Environment Protection Authority 1998, *Stormwater Prevention Code of Practice for the Building and Construction Industry*, EPA, Adelaide.

Hill, AJ, Lawson, JS, Mustafa, S 2002, The Hydrostratigraphy of the Tertiary Gambier Limestone Unconfined Aquifer, Lower South East South Australia. Report Book 2002/30 (unpublished).

Institution of Engineers, Australia 2003, Australian runoff quality (ARQ), Symposium proceedings, 16-17 June 2003.

Knox City Council 2002, 'Water-sensitive urban design guidelines for the City of Knox', Prepared by Murphy Design Group and KLM Development Consultants.

NSW Department of Housing (NSWDH) 1998, *Managing urban stormwater: Soils and construction*, NSWDH, Sydney.

NSW Environment Protection Authority (NSW EPA) 1997, 'Managing urban stormwater: Treatment techniques draft', NSW EPA, Sydney.

Pilgrim, DH (ed) 1987, *Australian rainfall and runoff (AR&R)—A guide to flood estimation*, Barton, ACT: Institution of Engineers, Australia.

Planning South Australia (Planning SA) 2003, 'On-site retention of stormwater', Minister's Specification SA 78AA.

South East Catchment Water Management Board (SECWMB) 2003, *South East Catchment Water Management Plan 2003-2008*, SECWMB.

Texas Natural Resource Conservation Commission (TNRCC) 1999, *Complying with the Edwards aquifer rules: Technical guidance on best management practices*, Austin, Texas.

Transport SA 2002, *Protecting waterways*, Prepared by the Environment Operations Unit, SOGC and the Stormwater Services Section with the assistance of the Urban Water Resources Centre of the University of South Australia.

## 15 APPENDIX A—DOUBLE RING INFILTROMETER TEST

The double ring infiltrometer test (American Society for Testing and Materials (ASTM) D3385—94) is a simple and inexpensive method for determining the in-situ infiltration capacity of soils. This method is particularly suitable for relatively uniform fine-grained soils with an absence of very plastic clays and gravel sized particles. The double ring infiltrometer test consists of driving two open cylinders, one inside the other, into the ground, partially filling the rings with water, and then maintaining the liquid at a constant level. The test may be conducted at the ground surface, at given depths in pits, on bare ground or on ground with vegetation in place.



Figure A1 Double ring infiltrometer

This test method is difficult to use, or the resultant data may be unreliable, or both, in very pervious or impervious soils or in dry or stiff soils that most likely will fracture when the rings are installed. It must be noted that the test cannot be used to directly determine the hydraulic conductivity of the soil. Although the units of infiltration and hydraulic conductivity of soils are the same (m/s), there is a distinct difference between these two quantities. They cannot be directly related unless the hydraulic boundary conditions are known—for example, by knowing the hydraulic gradient and being able to reliably estimate the extent of the lateral flow of water.

Many factors affect the infiltration rate, such as the:

- soil structure
- soil layering
- condition of the soil surface
- degree of saturation of the soil
- chemical and physical nature of the soil and of the applied liquid
- head of the applied liquid
- temperature of the liquid
- diameter and depth of the embedment rings.

Thus, tests made at the same site are unlikely to give identical results, and the rate measured by the test method described in this standard is primarily for comparative use. The following summarises the test method, as detailed in ASTM D3385-94.

## Apparatus

- **Infiltrometer rings:** open cylinders approximately 500 mm high with diameters of approximately 300 and 600 mm. Larger cylinders may be used providing the ratio of the outer to inner cylinders is approximately 2:1. Cylinders can be made of 3 mm hard alloy, aluminium sheet or other material sufficiently strong to withstand hard driving, with the bottom edge bevelled.
- **Driving caps:** disks of 13 mm thick hard alloy aluminium with centring pins around the edge or, preferably, a recessed groove approximately 5 mm deep and approximately 1 mm wider than the thickness of the ring. The diameters of the disks should be slightly larger than those of the infiltrometer rings.
- **Driving equipment:** a 5.5 kg rubber mallet or sledge and a 600 or 900 mm length of wood approximately 50 by 100 mm or 100 by 100 mm.
- **Depth gauge:** a hook gauge, steel tape or rule, or length of steel or plastic rod pointed on one end, for use in measuring and controlling the depth of the liquid (head) in the infiltrometer ring, when either a graduated Mariotte tube or automatic flow control system is not used.
- **Liquid containers:**
  1. one 200 L barrel for the main liquid supply, along with a length of rubber hose to siphon liquid from the barrel to fill the calibrated head tanks
  2. one 13 L bucket for initial filling of the infiltrometers
  3. two calibrated head tanks for measurement of liquid flow during the test. These may be either graduated cylinders or Mariotte tubes having a minimum capacity of approximately 3000 mL. It is useful to have one head tank with a capacity three times that of the other because the area of the annular space between the rings is approximately three times that of the inner ring. It must also be noted that the volume of the calibrated head tanks may need to be significantly larger than 3000 mL, particularly if the test is to be conducted overnight. A capacity of approximately 50 L would not be uncommon.
- **Liquid supply:** clean water (tap water is preferred)
- **Watch or stopwatch:** a stopwatch would only be required for high infiltration rates.
- **Level:** a carpenter's level.

## Calibration

- **Rings:**
  1. Determine the area of each ring and of the annular space between the rings (equal to the internal area of the 600 mm ring minus the external area of the 300 mm ring) before initial use.
  2. Determine these areas using a measuring technique that will provide an overall accuracy to within 1%.
  3. Redetermine these measurements before reuse after anything has occurred, including repairs, which may affect the test results significantly.
- **Liquid containers:** For each graduated cylinder or graduated Mariotte tube, establish the relationship between the change in elevation of liquid level and the change in the volume of the liquid. This relationship should have an overall accuracy to within 1%.

## Procedure

- **Test site:**
  1. The test requires an area of approximately 3 x 3 m.

2. The test site should be nearly level, or a level surface should be prepared.
  3. The test may be set up in a pit if infiltration rates are desired at depth rather than at the surface.
- **Driving infiltration rings:**
    1. Place the driving cap on the outer ring and centre it. Place the wood block on the driving cap.
    2. Drive the outer ring into the soil with blows of a heavy sledge onto the wood block to a depth that will:
      - prevent the test liquid from leaking to the ground surface surrounding the ring, and
      - be deeper than the depth to which the inner ring will be driven—a depth of 150 mm is usually adequate.
    3. Use blows of medium force to prevent fracturing of the soil surface.
    4. Move the wood block around the edge of the driving cap every one or two blows so that the ring will penetrate the soil uniformly.
    5. Centre the smaller ring inside the larger ring and drive to a depth that will prevent leakage of the test liquid to the ground surface surrounding the ring—a depth of approximately 50-100 mm is usually adequate.
  - **Tamping disturbed soil:**
    1. If the surface of the soil surrounding the wall(s) of the ring(s) is excessively disturbed (signs of cracking, excessive heave, etc.), reset the ring(s) using a technique that will minimise such disturbance.
    2. If the surface of the soil surrounding the wall(s) of the ring(s) is only slightly disturbed, tamp the disturbed soil adjacent to the inside and outside wall(s) of the ring(s) until the soil is as firm as it was prior to disturbance.
  - **Maintaining liquid level:**
    1. There are basically three ways to maintain a constant head (liquid level) within the inner ring and annular space between the two rings:
      - manual control of the flow of the liquid—a depth gauge is required to assist the investigator visually in maintaining a constant head, e.g. a steel tape or rule for soils having relatively high permeability, and a hook gauge or simple point gauge for soils having a relatively low permeability
      - the use of constant level float valves
      - the use of a Mariotte tube.
    2. Install the depth gauges, constant level valves or Mariotte tubes as shown in Figure A1, and in such a manner that the reference head will be at least 25 mm and not greater than 150 mm. Select the head on the basis of the permeability of the soil. Locate the depth gauges near the centre of the inner ring and midway between the two rings.
    3. Cover the soil surface within the inner ring and between the two rings with splash guards (square pieces of plastic sheeting) to prevent erosion of the soil when the initial liquid is poured into the rings.
    4. Use a pail to fill both rings with liquid to the same desired depth in each ring. Do not record this initial volume of liquid. Remove the splash guards.
    5. Start the flow of liquid from the graduated cylinders or Mariotte tubes. As soon as the level becomes basically constant, determine the liquid depth in both the inner ring and the annular

space to the nearest 2 mm using a ruler or tape measure. Record these depths. If the depths of liquid in the inner ring and annular space differ by more than 5 mm, raise the depth gauge, constant level float valve or Mariotte tube having the shallowest depth.

6. Maintain the liquid level at the selected head in both the inner ring and annular space as near as possible throughout the test, to prevent flow of liquid from one ring to the other.

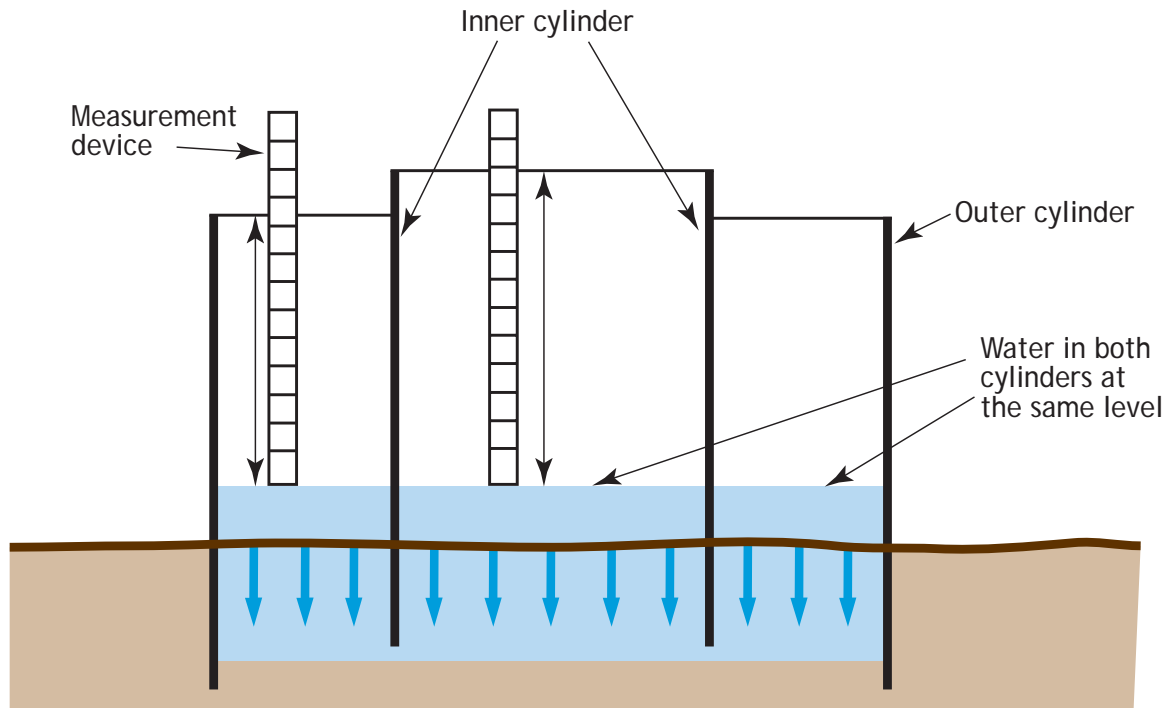

Figure A2 Setup of the double ring infiltrometer test

## Double ring infiltrometer test method

### Measurements

1. Determine and record the volume of liquid that is added to maintain a constant head in the inner ring and annular space during each time interval by measuring the change in elevation of the liquid level in the appropriate graduated cylinder or Mariotte tube.
2. For average soils, record the volume of liquid used at intervals of 15 minutes for the first hour, 30 minutes for the second hour and 60 minutes during the remainder of the period of at least 6 hours, or until after a relatively constant rate is obtained.
3. The appropriate schedule of readings may be determined only through experience. For high permeability soils, readings may be more frequent; while for low permeability soils, the reading interval may be 24 hours or more. In any event, the volume of liquid used in any one reading interval should not be less than approximately 25 mL.
4. Place the driving cap or some other covering over the rings during the intervals between liquid measurements to minimise evaporation. The covering should be vented to the atmosphere through a small hole or tube.

5. Upon completion of the test, remove the rings from the soil, assisted by light hammering on both sides with a rubber hammer.

### Calculations

1. Convert the volume of liquid used during each measured time interval into an incremental infiltration velocity for both the inner ring and annular space using the following equations:

- **For the inner ring:**

$$V_{ir} = \frac{V_{ir}}{(A_{ir} \times t)}$$

where

$V_{ir}$  = inner ring incremental infiltration velocity (m/s)

$V_{ir}$  = volume of liquid used during time interval to maintain constant head in the inner ring (m<sup>3</sup>).

(Note 1 m<sup>3</sup> = 1000 L)

$A_{ir}$  = internal area of the inner ring (m<sup>2</sup>)

$t$  = time interval (s)

- **For the annular space between the rings:**

$$V_a = \frac{V_a}{(A_a \times t)}$$

where

$V_a$  = annular space incremental infiltration velocity (m/s)

$V_a$  = volume of liquid used during time interval to maintain constant head in the annular space between the rings (m<sup>3</sup>). (Note 1 m<sup>3</sup> = 1000 L)

$A_a$  = area of annular space between the rings (m<sup>2</sup>)

$t$  = time interval (s)

2. The incremental infiltration velocities ( $V_{ir}$  and  $V_a$ ) are then plotted versus elapsed time on a graph.
3. The maximum steady state or average incremental infiltration velocity, depending on the purpose/application of the test, is the equivalent infiltration rate. If the rates for the inner ring and annular space differ, the value for the inner ring should be the value used.

### Reporting

**Report the following information in the report or field records, or both:**

- location of the test site
- dates of test, start and finish times
- weather conditions, start to finish
- name(s) of technician(s)
- description of test site, including soil type
- type of liquid used
- areas of the rings and annular space between the rings
- volume constants for the graduated cylinders or Mariotte tubes
- depths of liquid in inner ring and annular space
- record of incremental volume measurements and incremental infiltration velocities (inner ring and annular space) versus elapsed time
- if available, depth to the watertable and a description of the soils found between the rings and the watertable, or to a depth of approximately 1 m
- a plot of the incremental infiltration rate versus total elapsed time.

## Reference

The American Society for Testing and Materials (ASTM) 1994, 'D 3385–94 *Standard test method for infiltration rate of soils in field using double ring infiltrometer*', Under the jurisdiction of ASTM Committee D-18 on Soil and Rock.